

**HYDRO INTER**  
HYDRAULIC & PNEUMATIC EQUIPMENT

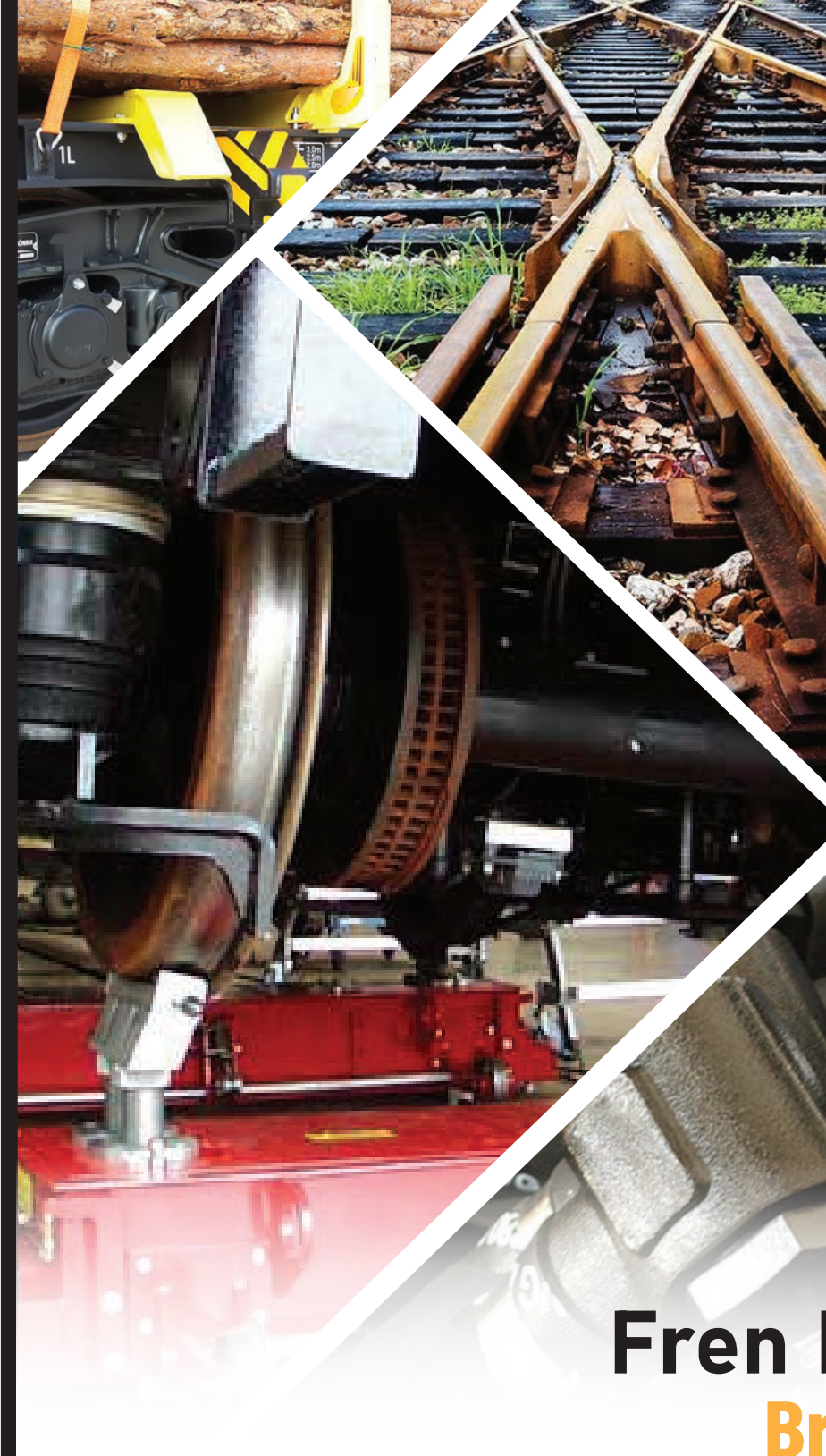

**Fren Rakorları**  
**Brake Unions**

**O-ring:**

Sızdırmazlık, her uygulama türü için tasarlanmış bir elastik o-ring ile sağlanır.

**Yıkayıcı:**

Elastik o-ring koruması için

**Yüzük :**

Kavrama, boru malzemesine uygun yuvarlak halka veya ayrıık konik halka ile sağlanır.

**O-ring :**

Tightness is ensured with one elastic o-ring designed for each type of application

**Washer :**

For elastic o-ring protection

**Ring :**

Gripping is ensured with a round-ring or split tapered ring appropriate to the tube material.

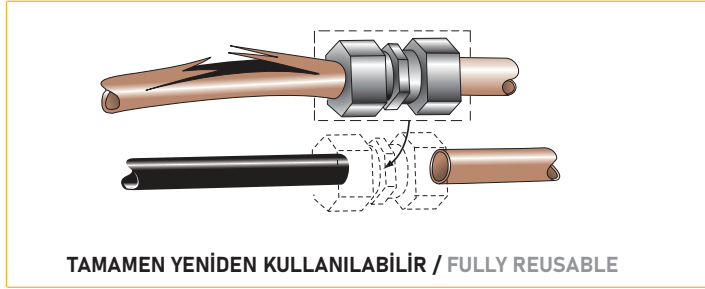

Birçok alanda onlarca yıldır kullanılan geniş bir kompresyon bağlantı parçası serisi:

- Yüksek titreşim ve şok ortamlarında.
- Güvenlik gerektiren(fren sistemleri, radyo koruması...)

Hydrointer bağlantı parçalarının asla bozulmayan güvenilirliği, marka adının uluslararası itibarını sağlamıştır. 2008 yılından beri Hydrointer üretimi ISO 9001 sertifikası ile garanti edilmektedir ve en modern üretim ekipmanlarını kullanmaktadır. (bilgisayar destekli üretim yönetimi, CAD, CAM). Montaj kolaylığı, boruları takarken zamandan tasarruf sağlar:

- Borunun ucundaki çapakları almaktan başka hazırlık yok (diş açma, kaynak yapma, flanş açma yok).
- Tüp için gönye dışı 5°'ye kadar kabul edilir.
- Herhangi bir özel alet kullanmadan ayarlama (Gerekli olan tek şey 2 anahtardır).

A wide range of compression fittings used for decades in many fields:

- In high shock and shock environments.
- Safety requirements (brake systems, radio protection...)

The unwavering reliability of Hydrointer fittings ensures the international reputation of the brand name. Since 2008, Hydrointer production is guaranteed by ISO 9001 certification and uses the most modern production equipment. (computer aided manufacturing management, CAD, CAM). Ease of installation saves when installing pipes:

- No preparation other than removing the anchors at the end of the pipe (no threading, welding, flanging).
- Up to 5° out of Miter is accepted for the tube.
- Adjustment without any special tools (All that is needed is key 2).

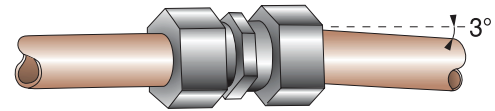

YANLIŞ HİZALAMA(MAKS 3°) / MISALIGNMENT (MAX 3°)

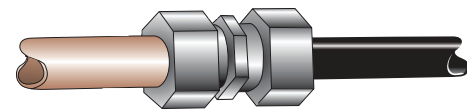

BENZER MALZEMELERİN BİRLEŞTİRİLMESİ  
JOINING OF ASIMILAR MATERIALS

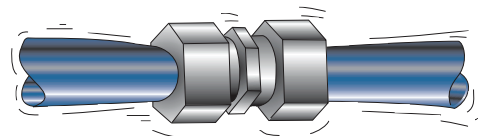

YÜKSEK TİTREŞİM DİRENCİ / HIGH VIBRATION RESISTANCE

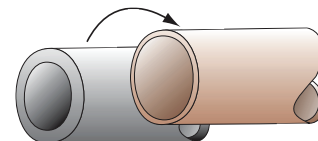

MALZEME TASARRUFU / MATERIAL SAVINGS

## SEÇİMİNİZİN UYGUNLUĞU AÇIKLAMA KODU (HARFLER) VEYA SİPARİŞ KODU (NUMARALAR) İLE TANIMLANABİLİR THE FITTING OF YOUR CHOICE CAN BE DEFINED THROUGH ITS DESCRIPTION CODE (LETTERS) OR ITS ORDER CODE (NUMBERS)

■ **Açıklama kodu** : Belirtilmesi zorunludur  
Description code : It is necessary to specify

- Bağlantı Tipi (U = Düz rakor,...)
- Montaj Malzemesi (AC = Katyonik Elektro Boya Çeliği,...)
- Boytlar (Boru ve İplik)
- O-Ring Malzemesi (JN = Nitril,...)
- Kavrama Bileşenleri (JAB = Sarı Çinko Kaplı yuvarlak halka + sarı çinko kaplı rondela, vb...)

- The fitting type (U = Straight union, ...)
- The fitting material (AC = cationic electropaint steel, ...)
- The dimensions (tube and thread)
- The o-ring material (JN = nitrile)
- The gripping components (JAB = yellow zinc coated round-ring + yellow zinc coated washer, etc ...)

■ **Sipariş kodu** : Numara grupları ile çeşitli özelliklerini belirtmek gerekir.  
Order code : It is necessary to state the various features of fitting with groups of numbers.

### Sipariş Kodu / Order Code

**XX XX - X XX - XX XX**

Fitting Tipi Fitting Type	Gövde - Somun Body - Nut	O - Ring O - Ring	Tutucu Bileşenler Gripping Components	Boyutlar Dimensions
Şuradan Bakınız Sayfa 8 / 26  See From Pages 8 to 26	<b>A = Fosfatlı çelik</b> = 10 <b>A = Phosphated steel</b>	<b>JN</b> Nitril Nitrile	<b>JAB</b> Yuvarlak Halka + Pul Sarı Çinko Kaplı Çelik Round ring + Washer Yellow Zinc Coated Steel	10 ou 12
	<b>AC = Katyonik çelik</b> = 13 <b>AC = Cationic steel</b> = 13	<b>JV</b> FPM FPM	<b>BAB</b> Ayrık Konik Halka + Pul Sarı Çinko Kaplı Çelik Dış Split Tapered Ring + Washer Yellow Zinc Coated Steel	20 ou 22
	<b>AZ = Beyaz çinko kaplı çelik</b> = 16 <b>AZ = White zinc coated steel</b>	<b>JS</b> Silikon Silicone	<b>BX</b> Ayrık Konik Halka + Pul 304L Paslanmaz Çelik Split Tapered Ring + Washer 304L Stainless Steel- ISO	24
	<b>X = Paslanmaz çelik 304L</b> = 20 <b>X=Stainless steel 304L</b>	<b>JE</b> EPDM EPDM	<b>BX</b> Yivli Ayrık Konik Halka + Pul 304L Paslanmaz Çelik Grooved Split Tapered Ring + Washer 304L Stainless Steel	34
	<b>XL = Paslanmaz çelik 316L</b> = 21 <b>XL =Stainless steel 316L</b>	<b>JH</b> Grafit Graphite	<b>BXL</b> Ayrık Konik Halka + Pul 316L Paslanmaz Çelik Split Tapered Ring + Washer 316L Stainless Steel	25
	<b>XL = Pirinç</b> = 40 <b>L = Bras</b>	<b>JNBT</b> Nitril Düşük Sıcaklık Nitrile low temp	<b>BL</b> Ayrık Konik Halka + Pul Pirinç Split Tapered Ring + Washer Brass	27
	<b>D = Eloksallı alüminyum</b> = 30 <b>D = Anodised aluminium</b>		<b>BD</b> Ayrık Konik Halka + Pul Alüminyum Split Tapered Ring + Washer Aluminium	21

Örnek: Nitril O-Ringler, sarı çinko kaplı ayrıık konik halka ve rondela ile katyonik çelik çap 25 dirsek.

Açıklama : EAC JN BAB 25 - Kodlama : CS19-122-2500 veya CS19-120-2500

Herhangi bir ek bilgiye ihtiyacınız olursa, lütfen bizimle iletişime geçmekten çekinmeyin. Tablolarda belirtilen sipariş kodları, gaz boruları için yuvarlak halkalarla ve metrik borular için ayrıık konik halkalarla donatılmış bağlantı parçalarına karşılık gelir.

Example : Elbow in cationic steel diameter 25 with nitrile o-rings, yellow zinc coated split tapered ring and washer.

Description : EAC JN BAB 25 - Codification : CS19-122-2500 or CS19-120-2500

Should you need any additional information, please do not hesitate to contact us.

The order codes mentioned in the tables correspond to fittings equipped with round rings for gas tubes and with split tapered rings for metric tubes.

## Standart Bağlantı Takımının Belirlenmesi Designation Of A Standard Fitting

Bir armatürün kodu önce boru tarafı (1) (veya adaptör tarafı), ardından cihaz tarafı (2) olarak tanımlanır (sonraki örneğe bakın).  
The code of a fitting is defined first by the pipe side (1) (or adaptor side) then by the device side (2) (see example here after).

**Paralel Erkek Bağlantı**  
Parallel Male Union

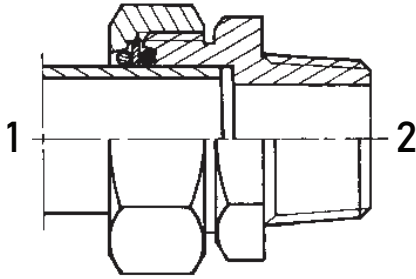

**Zayıflatıcı Rakor Adaptör**  
Reducing Union Adaptor

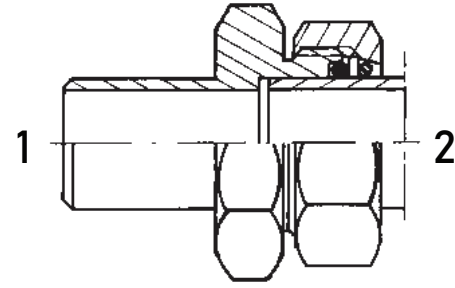

## Redüksiyon Bağlantının Çizimleri Illustration Of A Reducing Fitting

İstek üzerine, Hydrointer aşağıdaki resimlere göre redüksiyon armatürlerini üretebilir.  
Bir fittingi tanımlamak için A, B, C ve ardından D okuma talimatlarına dikkat edin.

On request, Hydrointer can manufacture the reducing fittings following the illustrations here after.  
To define a fitting, take care to the reading instruction A, B, C, then D.

**Paralel Erkek Bağlantı**  
Reducing Union

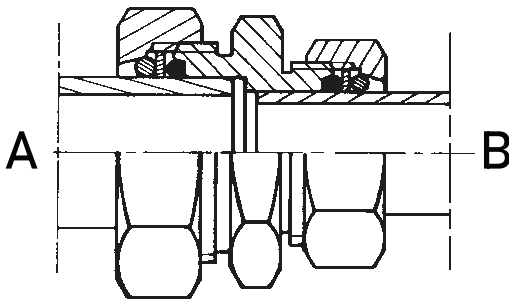

1 ve 2. Sayfadakinden farklı boyutlar  
Others dimensions than on page 1 and 2

**Basınç Düşürücü T**  
Reducing Tee

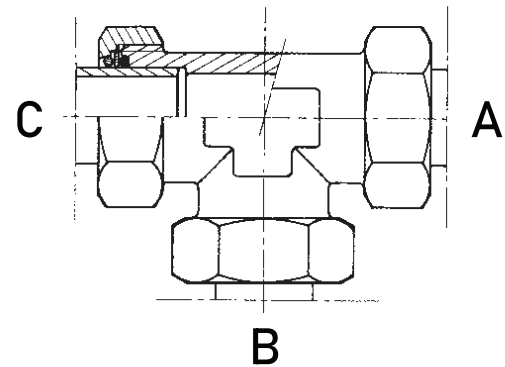



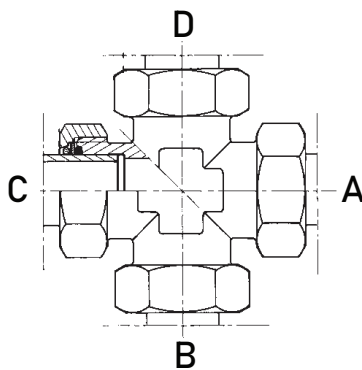



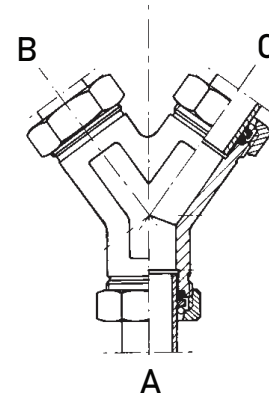









































**Basınç Düşürücü Kros**  
Reducing Cross



**Basınç Düşürücü Y**  
Reducing Y Branch



<p><b>U</b> </p>  <p>Sayfa : 1 / Page : 1</p>	<p><b>UR</b> </p>  <p>Sayfa : 2 / Page : 2</p>	<p><b>PC</b> </p>  <p>Sayfa : 3 / Page : 3</p>	<p><b>B0</b> </p>  <p>Sayfa : 4 / Page : 4</p>
<p><b>UM / UMG</b> </p>  <p>Sayfa : 5-6 / Page : 5-6</p>	<p><b>UMC / UMN</b> </p>  <p>Sayfa : 7-8 / Page : 7-8</p>	<p><b>UMI / UMCI</b> </p>  <p>Sayfa : 9-10-11 / Page : 9-10-11</p>	<p><b>UMNI</b> </p>  <p>Sayfa : 12 / Page : 12</p>
<p><b>UF / UFN</b> </p>  <p>Sayfa : 13-14-15 / Page : 13-14-15</p>	<p><b>AM</b> </p>  <p>Sayfa : 16-17 / Page : 16-17</p>	<p><b>AMC / AMN</b> </p>  <p>Sayfa : 18-19 / Page : 18-19</p>	<p><b>AF / AFN</b> </p>  <p>Sayfa : 20-21-22 / Page : 20-21-22</p>
<p><b>AUR</b> </p>  <p>Sayfa : 23 / Page : 23</p>	<p><b>E</b> </p>  <p>Sayfa : 24 / Page : 24</p>	<p><b>T</b> </p>  <p>Sayfa : 25 / Page : 25</p>	<p><b>C</b> </p>  <p>Sayfa : 26 / Page : 26</p>
<p><b>Y</b> </p>  <p>Sayfa : 27 / Page : 27</p>	<p><b>EM</b> </p>  <p>Sayfa : 28-29 / Page : 28-29</p>	<p><b>EMC / EMN</b> </p>  <p>Sayfa : 30-31 / Page : 30-31</p>	<p><b>OR</b> </p>  <p>Sayfa : 32-33 / Page : 32-33</p>
<p><b>PP</b> </p>  <p>Sayfa : 34 / Page : 34</p>	<p><b>DPP</b> </p>  <p>Sayfa : 35 / Page : 35</p>	<p><b>OB</b> </p>  <p>Sayfa : 36 / Page : 36</p>	<p><b>EC-JT-RD</b> </p>  <p>Sayfa : 37 / Page : 37</p>

U

CS01 Serisi / CS01 Series

Düz Rakor / Straight Union

Tüp O.D mm	Tube O.D inch	A	B	L	Ağırlık (g) Çelik Steel	Weight (g) Pirinç Brass	Sipariş Kodu Order code Çelik Steel
6		17	14	33	41	47	CS01-120-0600
8		19	17	33	51	58	CS01-120-0800
10		22	19	35	67	77	CS01-120-1000
12		24	22	38	73	83	CS01-120-1200
14		27	24	38	98	112	CS01-120-1400
15		27	24	42	115	132	CS01-120-1500
16		30	27	42	128	147	CS01-120-1600
18		30	27	44	112	128	CS01-120-1800
20		32	30	47	128	147	CS01-120-2000
22		36	36	48	176	202	CS01-120-2200
25		41	36	47	226	259	CS01-120-2500
28		46	41	48	305	350	CS01-120-2800
30		46	46	55	390	448	CS01-120-3000
35		50	46	58	350	402	CS01-120-3500
38		55	50	58	410	471	CS01-120-3800
40		60	55	56	515	592	CS01-120-4000
44.5		65	65	65	715	822	CS01-120-4400

10.2	1/8	22	19	37	70	80	CS01-110-7100
13.5	1/4	27	24	38	95	109	CS01-110-7200
17.2	3/8	30	27	43	123	141	CS01-110-7300
21.3	1/2	36	32	46	190	218	CS01-110-7400
26.9	3/4	46	41	48	310	356	CS01-110-7500
33.7	1"	50	46	55	380	437	CS01-110-7600
42.4	1" 1/4	65	60	63	698	802	CS01-110-7700
48.3	1" 1/2	70	65	67	774	890	CS01-110-7800
60.3	2"	85	80	78	1332	1531	CS01-110-7900

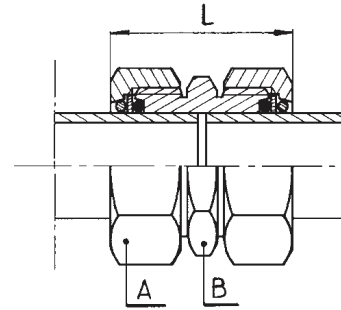

Yukarıda listelenen sipariş kodları standart bağlantı parçaları içindir. Diğer malzemeler, boyutlar ve ekipman istek üzerine gerçekleştirilebilir.  
The above listed order codes are for standard fittings. Other materials, sizes and equipment can be realised on request.

**UR**

CS02 Serisi / CS02 Series

**Redüksiyon Rakor / Reducing Union**

Tüp O.D / Tube O.D			A	Ad	B	LD	LF	LT	Ağırlık (g) / Weight (g)		Sipariş Kodu / Order code
mm	inch	mm/inch							Çelik Steel	Pirinç Brass	
8		6	19	17	17	19	13.5	16	47	54	CS02-120-0806
10		8	22	19	19	20	13.5	17	60	69	CS02-120-1008
12		10	24	22	22	22	15	18	71	81	CS02-120-1210
14		12	27	24	24	22	15	18	78	89	CS02-120-1412
15		12	27	24	24	25	15	18	92	105	CS02-120-1512
16		14	30	27	27	24	15	20	115	132	CS02-120-1614
18		16	30	30	27	25	17	22	118	135	CS02-120-1816
20		18	32	30	30	28	19	23	123	141	CS02-120-2018
22		20	36	32	36	28	19	24	167	192	CS02-120-2220
25		22	41	36	36	28	19	23	206	236	CS02-120-2522
28		25	46	41	41	29	19	23	276	317	CS02-120-2825
30		28	46	46	46	33	19	27	354	407	CS02-120-3028
35		32	50	50	46	34	22	28	350	402	CS02-120-3532
38		30	55	46	50	35	22	28	403	463	CS02-120-3830
40		38	60	55	55	34	23	27	502	577	CS02-120-4038
44.5		38	65	55	65	41	23	33	610	701	CS02-120-4438

13.5	1/4	1/8	27	22	24	22	15	18	73	83	CS02-110-7271
17.2	3/8	1/4	30	27	27	25	15	21	111	127	CS02-110-7372
21.3	1/2	3/8	36	30	32	27	18	22	165	189	CS02-110-7473
26.9	3/4	1/2	46	36	41	29	18	23	269	309	CS02-110-7574
33.7	1"	3/4	50	46	46	33	19	27	318	365	CS02-110-7675
42.4	1" 1/4	1"	65	50	60	39	22	31	564	648	CS02-110-7776
48.3	1" 1/2	1" 1/4	70	65	65	41	23	33	741	852	CS02-110-7877
60.3	2"	1" 1/2	85	70	80	49	25	38	1131	1300	CS02-110-7978

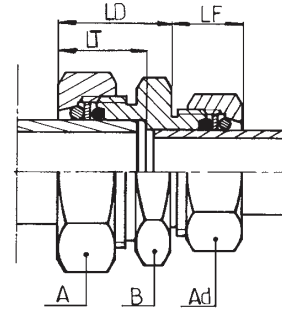

Yukarıda listelenen sipariş kodları standart bağlantı parçaları içindir. Diğer malzemeler, boyutlar ve ekipman istek üzerine gerçekleştirilebilir.  
The above listed order codes are for standard fittings. Other materials, sizes and equipment can be realised on request.

PC

CS03 Serisi / CS03 Series

Bölme Rakor Duvarı Kalınlığı 3 ila 10 mm / Bulkhead Unionwall Thickness 3 to 10 mm

Tüp O.D mm	Tube O.D		A	B	M	L	E	Ağırlık (g)		Sipariş Kodu Order code Çelik Steel
	inch	mm/inch						Çelik Steel	Pirinç Brass	
6			17	19	47	19	15	68	78	CS03-120-0601
8			19	22	48	20	17	83	95	CS03-120-0801
10			22	24	52	22	19	108	124	CS03-120-1001
12			24	27	53	22	22	121	139	CS03-120-1201
14			27	30	55	24	24	161	185	CS03-120-1401
15			27	30	60	27	25	182	209	CS03-120-1501
16			30	32	60	26	26	203	233	CS03-120-1601
18			30	32	62	27	28	104	119	CS03-120-1801
20			32	36	63	28	30	222	255	CS03-120-2001
22			36	41	66	30	34	313	359	CS03-120-2201
25			41	41	65	29	37	333	382	CS03-120-2501
28			46	46	67	30	39	447	514	CS03-120-2801
30			46	50	73	34	43	609	700	CS03-120-3001
35			50	55	76	36	47	540	621	CS03-120-3501
38			55	60	79	39	50	728	837	CS03-120-3801
40			60	60	77	38	53	815	937	CS03-120-4001
44.5			65	70	82	40	61	1131	13000	CS03-120-4401

10.2	1/8		22	24	52	22	19	106	121	CS03-110-7101
13.5	1/4		27	30	55	24	24	170	195	CS03-110-7201
17.2	3/8		30	32	61	27	27	209	240	CS03-110-7301
21.3	1/2		36	41	64	29	33	312	358	CS03-110-7401
26.9	3/4		46	46	66	30	39	449	516	CS03-110-7501
33.7	1"		50	55	73	34	47	580	667	CS03-110-7601
42.4	1" 1/4		65	65	80	39	59	1138	1308	CS03-110-7701
48.3	1" 1/2		70	75	86	41	64	1112	1278	CS03-110-7801
60.3	2		85	85	100	49	77	1742	2003	CS03-110-7901

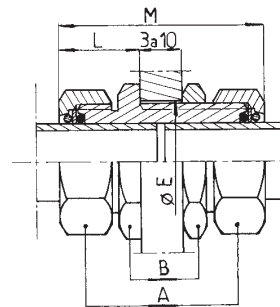

E = Duvar için minimum delme çapı  
E = Minimum boring diameter for the wall

Yukarıda listelenen sipariş kodları standart bağlantı parçaları içindir. Diğer malzemeler, boyutlar ve ekipman istek üzerine gerçekleştirilebilir.  
The above listed order codes are for standard fittings. Other materials, sizes and equipment can be realised on request.



**BO**

CS04 Serisi / CS04 Series

**Son Tüp Tapası / End Tube Plug**

Tüp O.D mm	Tube O.D inch mm/inch		A	B	N	LT	Ağırlık (g) Çelik Steel		Sipariş Kodu Order code Çelik Steel
	inch	mm/inch					Pirinç Brass	Weight (g)	
6			17	14	17	14	22	25	CS04-120-0600
8			19	17	17	14	28	32	CS04-120-0800
10			22	19	19	17	38	43	CS04-120-1000
12			24	22	20	17	43	49	CS04-120-1200
14			27	24	21	18	54	62	CS04-120-1400
15			27	24	22	19	63	72	CS04-120-1500
16			30	27	23	20	78	89	CS04-120-1600
18			30	27	24	21	70	80	CS04-120-1800
20			32	30	24	21	79	90	CS04-120-2000
22			36	36	26	22	116	133	CS04-120-2200
25			41	36	25	21	131	150	CS04-120-2500
28			46	41	25	22	174	200	CS04-120-2800
30			46	46	28	24	229	263	CS04-120-3000
35			50	46	31.5	27	205	235	CS04-120-3500
38			55	50	33	28	280	322	CS04-120-3800
40			60	55	32	26	361	415	CS04-120-4000
44.5			65	65	35	28	428	492	CS04-120-4400

10.2	1/8		22	19	19	17	37	42	CS04-110-7100
13.5	1/4		27	24	21	18	55	63	CS04-110-7200
17.2	3/8		30	27	23	20	74	85	CS04-110-7300
21.3	1/2		36	32	25	21	111	127	CS04-110-7400
26.9	3/4		46	41	25	22	178	204	CS04-110-7500
33.7	1"		50	46	28	24	202	232	CS04-110-7600
42.4	1" 1/4		65	60	33	28	417	279	CS04-110-7700
48.3	1" 1/2		70	65	35	30	498	572	CS04-110-7800
60.3	2"		85	80	41	34	987	1135	CS04-110-7900

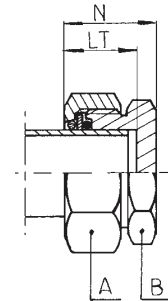

Yukarıda listelenen sipariş kodları standart bağlantı parçaları içindir. Diğer malzemeler, boyutlar ve ekipman istek üzerine gerçekleştirilebilir.  
The above listed order codes are for standard fittings. Other materials, sizes and equipment can be realised on request.

UM

CS05 Serisi / CS05 Series

Paralel Erkek Birliđi BSPP / Parallel Male Union BSPP										Uzun Erkek Birliđi BSPP * Long Male Union BSPP *						
Tüp O.D Tube O.D			A	B	N	LT	I	Ağırlık(g) Weight(g)		Sipariş Kodu Order code		A	B	N	Ağırlık(g) Weight(g)	
mm	inch	mm/inch						Çelik Steel	Pirinç Brass	Çelik Steel	Steel				Çelik Steel	Pirinç Brass
6		G1/8B	17	17	21	16	6	34	37	CS05-120-0671		8	29	24	47	54
8		G1/4B	19	22	21	16	8	45	50	CS05-120-0872		10	31	26	66	75
10		G1/4B	22	22	23	18	8	53	59	CS05-120-1072		10	33	28	71	81
12		G3/8B	24	24	23	19	8	61	67	CS05-120-1273		10	34	29	91	104
14		G3/8B	27	27	24	19	8	61	67	CS05-120-1473		10	34	29	88	101
15		G3/8B	27	27	25	18	8	70	78	CS05-120-1573		10	35	28	95	109
16		G3/8B	30	27	26	21	8	113	125	CS05-120-1673		10	36	31	146	167
18		G1/2B	30	32	28	22	10	106	118	CS05-120-1874		12	40	34	165	189
20		G1/2B	32	36	30	23	10	102	113	CS05-120-2074		12	42	35	155	178
22		G1/2B	36	36	30	24	10	153	170	CS05-120-2274		12	42	36	223	256
25		G3/4B	41	41	30	23	14	170	189	CS05-120-2575		16	46	39	249	286
28		G1" B	46	46	30	24	14	252	280	CS05-120-2876		16	46	40	357	410
30		G1" B	46	46	34	27	14	295	328	CS05-120-3076		16	50	43	354	407
35		G1" 1/4B	50	50	36	29	16	441	491	CS05-120-3577		18	58	47	745	856
38		G1" 1/4B	55	55	39	29	16	468	521	CS05-120-3877		18	57	47	748	860
40		G1" 1/2B	60	60	38	28	16	572	637	CS05-120-4078		18	56	46	910	1046
44.5		G1" 1/2B	65	65	41	32	16	582	648	CS05-120-4478		18	59	50	883	1015

10.2	1/8	G1/4B	22	22	22	17	8	51	56	CS05-110-7172		10	32	27	69	79
13.5	1/4	G1/4B	27	24	24	19	8	76	84	CS05-110-7272		10	34	29	104	119
17.2	3/8	G3/8B	30	27	26	21	8	92	102	CS05-110-7373		10	36	31	123	141
21.3	1/2	G1/2B	36	32	29	23	10	139	154	CS05-110-7474		12	41	35	190	218
26.9	3/4	G3/4B	46	41	30	24	14	166	185	CS05-110-7575		16	46	40	276	317
33.7	1"	G1" B	50	46	34	27	14	260	289	CS05-110-7676		16	50	43	329	378
42.4	1" 1/4	G1" 1/4B	65	60	40	31	16	543	605	CS05-110-7777		18	58	49	787	905
48.3	1" 1/2	G1" 1/2B	70	65	42	33	16	677	754	CS05-110-7878		18	60	51	937	1077
60.3	2"	G2" B	85	80	49	39	18	1071	1193	CS05-110-7979		20	69	59	1497	1721

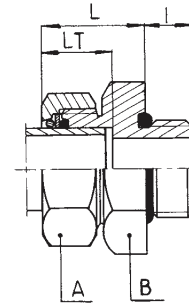

\* Uzun erkek rakor sipariş kodu için lütfen erkek rakor sipariş kodundaki CS05'i CS29 ile değiştirin.

\* For long male union order code please replace CS05 by CS29 in male union order code.

# UMG

CS05 Serisi / CS05 Series

Paralel Erkek Birliđi ISO / Parallel Male Union ISO											Uzun Erkek Birliđi ISO * Long Male Union ISO *					
Tüp O.D Tube O.D			A	B	N	LT	I	Ağırlık(g) Weight(g)		Sipariş Kodu Order code		X	L	LT	Ağırlık(g) Weight(g)	
mm	inch	mm/inch						Çelik Steel	Pirinç Brass	Çelik Steel	Steel				Çelik Steel	Pirinç Brass
6		M10X100	17	17	21	16	7	34	39	CS05-120-0610	9	30	25	52	59	
8		M12X100	19	22	21	16	7	45	51	CS05-120-0812	9	30	25	71	81	
10		M14X150	22	22	23	18	9	53	60	CS05-120-1014	11	34	29	82	94	
12		M16X150	24	24	23	19	9	61	70	CS05-120-1216	11	34	30	94	108	
14		M18X150	27	27	24	19	11	61	70	CS05-120-1418	13	37	32	110	126	
15		M18X150	27	27	25	18	11	80	92	CS05-120-1518	13	38	31	120	138	
16		M20X150	30	27	26	21	11	113	129	CS05-120-1620	13	39	34	157	180	
18		M22X150	30	32	28	22	12	106	121	CS05-120-1822	14	42	36	175	201	
20		M24X150	32	36	30	23	12	102	117	CS05-120-2024	14	44	37	190	218	
22		M27X150	36	36	30	24	14	153	175	CS05-120-2227	16	46	40	246	282	
25		M30X150	41	41	30	23	14	170	195	CS05-120-2530	16	46	39	290	333	
28		M33X200	46	46	30	24	15	252	289	CS05-120-2833	17	47	41	414	476	
30		M33X200	46	46	34	27	15	295	339	CS05-120-3033	17	51	44	450	517	
35		M39X200	50	50	36	29	16	441	507	CS05-120-3539	18	54	47	611	702	
38		M42X200	55	55	39	29	16	468	538	CS05-120-3842	18	57	47	747	859	
40		M45X200	60	60	38	28	16	572	657	CS05-120-4045	18	56	46	834	959	
44.5		M48X200	65	65	41	32	16	582	669	CS05-120-4448	18	59	50	885	1017	

10.2	1/8	M14X150	22	22	22	17	9	51	58	CS05-110-7114	11	33	28	80	92
13.5	1/4	M18X150	27	27	24	19	11	76	87	CS05-110-7218	13	37	32	126	144
17.2	3/8	M20X150	30	27	27	21	11	92	105	CS05-110-7320	13	40	34	133	152
21.3	1/2	M24X150	36	36	29	23	12	139	159	CS05-110-7424	14	43	37	224	257
26.9	3/4	M30X150	46	41	30	24	14	166	190	CS05-110-7530	16	46	40	270	310
33.7	1"	M39X200	50	50	34	27	16	260	299	CS05-110-7639	18	52	45	437	502
42.4	1" 1/4	M45X200	65	60	40	31	16	543	624	CS05-110-7745	18	58	49	788	906
48.3	1" 1/2	M48X200	70	65	42	33	16	677	778	CS05-110-7848	18	60	51	938	1078
60.3	2	M60X200	85	80	51	39	18	1071	1231	CS05-110-7960	20	71	59	1497	1721

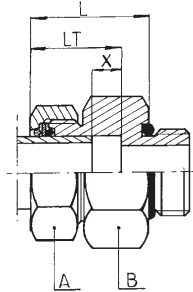

\* For long male union order code please replace 0213 by 8513 in male union order code.  
\* For long male union order code please replace 0213 by 8513 in male union order code.

Yukarıda listelenen sipariş kodları standart bağlantı parçaları içindir. Diğer malzemeler, boyutlar ve ekipman istek üzerine gerçekleştirilebilir.  
The above listed order codes are for standard fittings. Other materials, sizes and equipment can be realised on request.

UMC

CS06 Serisi / CS06 Series

Konik Erkek Rakor BSPT / Taper Male Union BSPT

Tüp O.D Tube O.D			A	B	L	LT	I	Ağırlık (g) Weight (g)		Sipariş Kodu Order code Çelik Steel
mm	inch	mm/inch						Çelik Steel	Pirinç Brass	
6		G1/8	17	14	19	16	9.5	28	31	CS06-120-0671
8		G1/4	19	17	19	16	12.5	36	40	CS06-120-0872
10		G1/4	22	19	20	18	12.5	46	51	CS06-120-1072
12		G3/8	24	22	22	19	12.5	59	65	CS06-120-1273
14		G3/8	27	24	22	19	12.5	74	82	CS06-120-1473
15		G3/8	27	24	24	18	12.5	90	100	CS06-120-1573
16		G3/8	30	27	24	21	12.5	94	104	CS06-120-1673
18		G1/2	30	27	25	22	17.5	94	104	CS06-120-1874
20		G1/2	32	30	28	23	17.5	118	131	CS06-120-2074
22		G1/2	36	36	28	24	17.5	166	185	CS06-120-2274
25		G3/4	41	36	28	23	19	195	217	CS06-120-2575
28		G1"	46	41	29	24	21	252	280	CS06-120-2876
30		G1"	46	46	33	27	21	325	362	CS06-120-3076
35		G1"1/4	50	46	34	29	24	331	368	CS06-120-3577
38		G1"1/4	55	50	35	29	24	395	440	CS06-120-3877
40		G1"1/2	60	55	34	28	24	500	557	CS06-120-4078
44.5		G1"1/2	65	65	41	32	24	645	718	CS06-120-4478

10.2	1/8	G1/4	22	19	21	17	12.5	44	49	CS06-110-7172
13.5	1/4	G1/4	27	24	22	19	12.5	67	74	CS06-110-7272
17.2	3/8	G3/8	30	27	25	21	12.5	94	104	CS06-110-7373
21.3	1/2	G1/2	36	32	27	23	17.5	148	164	CS06-110-7474
26.9	3/4	G3/4	46	41	29	24	19	243	270	CS06-110-7575
33.7	1"	G1"	50	46	33	27	21	291	324	CS06-110-7676
42.4	1" 1/4	G1"1/4	65	60	39	31	24	594	662	CS06-110-7777
48.3	1"1/2	G1"1/2	70	65	41	33	24	726	809	CS06-110-7878
60.3	2	G2"	85	80	49	39	27	1444	1609	CS06-110-7979

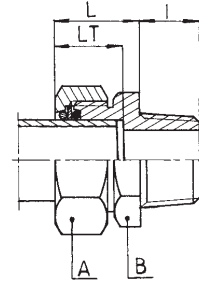

Yukarıda listelenen sipariş kodları standart bağlantı parçaları içindir. Diğer malzemeler, boyutlar ve ekipman istek üzerine gerçekleştirilebilir.

The above listed order codes are for standard fittings. Other materials, sizes and equipment can be realised on request.

# UMN

CS07 Serisi / CS07 Series

## Konik Erkek Rakor NPT / Taper Male Union NPT

Tüp O.D Tube O.D			A	B	L	LT	I	Ağırlık (g) Weight (g)		Sipariş Kodu Order code Çelik Steel
mm	inch	mm/inch						Çelik Steel	Pirinç Brass	
6		N1/8	17	14	19	16	8	29	32	CS07-120-0671
8		N1/4	19	17	19	16	12	38	42	CS07-120-0872
10		N1/4	22	19	20	18	12	47	52	CS07-120-1072
12		N3/8	24	22	22	19	12	64	71	CS07-120-1273
14		N3/8	27	24	22	19	12	74	82	CS07-120-1473
15		N3/8	27	24	24	18	12	90	100	CS07-120-1573
16		N3/8	30	27	24	21	12	99	110	CS07-120-1673
18		N1/2	30	27	25	22	16	98	109	CS07-120-1874
20		N1/2	32	30	28	23	16	126	140	CS07-120-2074
22		N1/2	36	36	28	24	16	166	185	CS07-120-2274
25		N3/4	41	36	28	23	16	194	216	CS07-120-2575
28		N1"	46	41	29	24	20	280	312	CS07-120-2876
30		N1"	46	46	33	27	20	370	412	CS07-120-3076
35		N1"1/4	50	46	34	29	20	274	305	CS07-120-3577
38		N1"1/4	55	50	35	29	20	395	440	CS07-120-3877
40		N1"1/2	60	55	34	28	22	402	448	CS07-120-4078
44.5		N1"1/2	65	65	41	32	22	685	763	CS07-120-4478

10.2	1/8	N1/4	22	19	21	17	12	47	52	CS07-110-7172
13.5	1/4	N1/4	27	24	22	19	12	64	71	CS07-110-7272
17.2	3/8	N3/8	30	27	25	21	12	91	101	CS07-110-7373
21.3	1/2	N1/2	36	32	27	23	16	156	173	CS07-110-7474
26.9	3/4	N3/4	46	41	29	24	16	228	254	CS07-110-7575
33.7	1"	N1"	50	46	33	27	20	322	358	CS07-110-7676
42.4	1" 1/4	N1"1/4	65	60	39	31	20	564	528	CS07-110-7777
48.3	1"1/2	N1"1/2	70	65	41	33	22	878	978	CS07-110-7878
60.3	2	N2"	85	80	49	39	22	1444	1609	CS07-110-7979

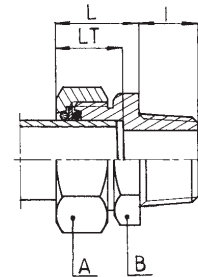

Yukarıda listelenen sipariş kodları standart bağlantı parçaları içindir. Diğer malzemeler, boyutlar ve ekipman istek üzerine gerçekleştirilebilir.  
The above listed order codes are for standard fittings. Other materials, sizes and equipment can be realised on request.

UMI

CS08 Serisi / CS08 Series

Paralel Erkek Birliđi Tam Geçiřli BSPP / Parallel Male Union Full Pass BSPP

Tüp O.D Tube O.D			A	B	L	I	Sipariř Kodu Order code Çelik Steel
mm	inch	mm/inch					
6		G1/4B	17	22	21	8	CS08-120-0672
8		G3/8B	19	24	21	8	CS08-120-0873
10		G3/8B	22	24	22	8	CS08-120-1073
12		G1/2B	24	32	25	10	CS08-120-1274
14		G3/4B	27	36	25	14	CS08-120-1475
15		G3/4B	27	36	26	14	CS08-120-1575
16		G3/4B	30	36	27	14	CS08-120-1675
18		G1" B	30	46	30	14	CS08-120-1876
20		G1" B	32	46	30	14	CS08-120-2076
22		G1" B	36	46	31	14	CS08-120-2276
25		G1" 1/4 B	41	60	35	16	CS08-120-2577
28		G1" 1/4 B	46	60	35	16	CS08-120-2877
30		G1" 1/4 B	46	60	38	16	CS08-120-3077
35		G1" 1/2 B	50	65	40	16	CS08-120-3578
38		G2" B	55	75	40	18	CS08-120-3879
40		G2" B	60	75	40	18	CS08-120-4079
44.5		G2" B	65	75	41	18	CS08-120-4479

10.2	1/8	G3/8B	22	24	24	8	CS08-110-7173
13.5	1/4	G3/4B	27	36	25	14	CS08-110-7275
17.2	3/8	G3/4B	30	36	27	14	CS08-110-7375
21.3	1/2	G1" B	36	46	30	14	CS08-110-7476
26.9	3/4	G1" 1/4 B	46	60	35	16	CS08-110-7577
33.7	1"	G1" 1/2 B	50	65	38	16	CS08-110-7678
42.4	1" 1/4	G2" B	65	75	40	18	CS08-110-7779

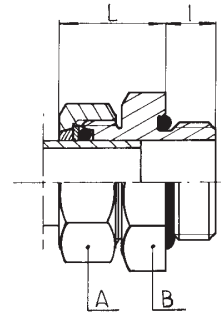

Yukarıda listelenen sipariř kodları standart bađlantı parçaları içindir. Diđer malzemeler, boyutlar ve ekipman istek üzerine gerçekleştirilebilir.

The above listed order codes are for standard fittings. Other materials, sizes and equipment can be realised on request.

## UMI

Bölme Birliđi / Reducing Union

### Paralel Erkek Birliđi Tam Geçiřli ISO / Parallel Male Union Full Pass ISO

Tüp O.D Tube O.D			A	B	L	I	Sipariř Kodu Order code Çelik Steel
mm	inch	mm/inch					
6		M14x150	17	22	21	9	CS08-120-0614
8		M16X150	19	24	21	9	CS08-120-0816
10		M18X150	22	27	22	11	CS08-120-1018
12		M20X150	24	27	24	11	CS08-120-1220
14		M22X150	27	32	25	12	CS08-120-1422
15		M24X150	27	36	26	12	CS08-120-1524
16		M27X150	30	36	27	14	CS08-120-1627
18		M30X150	30	41	29	14	CS08-120-1830
20		M33X200	32	46	30	15	CS08-120-2033
22		M33X200	36	46	21	15	CS08-120-2233
25		M39X200	41	50	21	16	CS08-120-2539
28		M39X200	46	50	23	16	CS08-120-2839
30		M42X200	46	60	38	16	CS08-120-3042
35		M48X200	50	65	41	16	CS08-120-3548

10.2	1/8	G3/8B	22	27	24	11	CS08-110-7118
13.5	1/4	G3/4B	27	27	24	11	CS08-110-7220
17.2	3/8	G3/4B	30	36	27	14	CS08-110-7327
21.3	1/2	G1"B	36	46	30	15	CS08-110-7433
26.9	3/4	G1"1/4B	46	50	31	16	CS08-110-7539
33.7	1"	G1"1/2B	50	60	38	16	CS08-110-7645

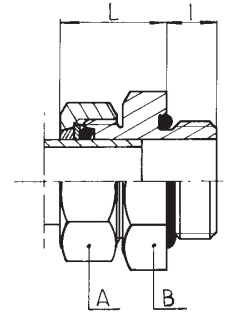

Yukarıda listelenen sipariř kodları standart bađlantı parçaları içindir. Diđer malzemeler, boyutlar ve ekipman istek üzerine gerçekleştirilebilir.  
The above listed order codes are for standard fittings. Other materials, sizes and equipment can be realised on request.

UMCI

Bölme Birliği / Reducing Union

Konik Erkek Rakor Tam Geçişli BSPT / Taper Male Union Full Pass BSPT

Tüp O.D Tube O.D			A	B	L	I	Sipariş Kodu Order code Çelik Steel
mm	inch	mm/inch					
6		G1/4	17	14	19	12.5	CS09-120-0672
8		G3/8	19	19	19	12.5	CS09-120-0873
10		G3/8	22	19	21	12.5	CS09-120-1073
12		G1/2	24	22	22	17.5	CS09-120-1274
14		G3/4	27	30	24	19	CS09-120-1475
15		G3/4	27	30	27	19	CS09-120-1575
16		G3/4	30	30	26	19	CS09-120-1675
18		G1"	30	36	27	21	CS09-120-1876
20		G1"	32	36	28	21	CS09-120-2076
22		G1"	36	36	28	21	CS09-120-2276
25		G1" 1/4	41	46	30	24	CS09-120-2577
28		G1" 1/4	46	46	30	24	CS09-120-2877
30		G1" 1/4	46	46	33	24	CS09-120-3077
35		G1" 1/2	50	50	35	24	CS09-120-3578
38		G2"	55	65	39	27	CS09-120-3879
40		G2"	60	65	38	27	CS09-120-4079
44.5		G2"	65	65	41	27	CS09-120-4479

10.2	1/8	G3/8	22	19	23	12.5	CS09-110-7173
13.5	1/4	G3/4	27	30	24	19	CS09-110-7275
17.2	3/8	G3/4	30	30	27	19	CS09-110-7375
21.3	1/2	G1"	36	36	28	21	CS09-110-7476
26.9	3/4	G1" 1/4	46	46	30	24	CS09-110-7577
33.7	1"	G1" 1/2	50	50	34	24	CS09-110-7678
42.4	1" 1/4	G2"	65	65	39	27	CS09-110-7779

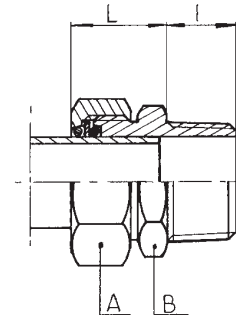

Yukarıda listelenen sipariş kodları standart bağlantı parçaları içindir. Diğer malzemeler, boyutlar ve ekipman istek üzerine gerçekleştirilebilir.

The above listed order codes are for standard fittings. Other materials, sizes and equipment can be realised on request.



## UMNI

CS10 Serisi / CS10 Series

### Konik Erkek Rakor Tam Geçişli NPT / Taper Male Union Full Pass NPT

Tüp O.D mm	Tube O.D		A	B	L	I	Sipariş Kodu Order code Çelik Steel
	inch	mm/inch					
6		N1/4	17	17	19	12	CS10-120-0672
8		N3/8	19	19	19	12	CS10-120-0873
10		N3/8	22	19	21	12	CS10-120-1073
12		N1/2	24	24	22	16	CS10-120-1274
14		N3/4	27	30	24	16	CS10-120-1475
15		N3/4	27	30	27	16	CS10-120-1575
16		N3/4	30	30	26	16	CS10-120-1675
18		N1"	30	36	27	20	CS10-120-1876
20		N1"	32	36	28	20	CS10-120-2076
22		N1"	36	36	28	20	CS10-120-2276
25		N1"1/4	41	46	30	20	CS10-120-2577
28		N1"1/4	46	46	30	20	CS10-120-2877
30		N1"1/4	46	46	33	20	CS10-120-3077
35		N1"1/2	50	50	35	22	CS10-120-3578
38		N2"	55	65	39	22	CS10-120-3879
40		N2"	60	65	38	22	CS10-120-4079
44.5		N2"	65	65	41	22	CS10-120-4479

10.2	1/8	N3/8	22	19	23	12	CS10-110-7173
13.5	1/4	N3/4	27	30	24	16	CS10-110-7275
17.2	3/8	N3/4	30	30	27	16	CS10-110-7375
21.3	1/2	N1"	36	36	28	20	CS10-110-7476
26.9	3/4	N1"1/4	46	46	30	20	CS10-110-7577
33.7	1"	N1"1/2	50	50	34	22	CS10-110-7678
42.4	1"1/4	N2"	65	65	39	22	CS10-110-7779

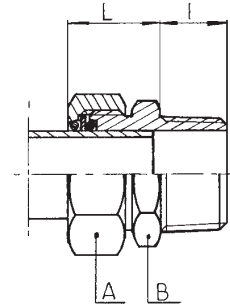

Yukarıda listelenen sipariş kodları standart bağlantı parçaları içindir. Diğer malzemeler, boyutlar ve ekipman istek üzerine gerçekleştirilebilir.  
The above listed order codes are for standard fittings. Other materials, sizes and equipment can be realised on request.

UF

CS11 Serisi / CS11 Series

Paralel Dişi Rakor BSPP / Parallel Female Union BSPP

Tüp O.D / Tube O.D			A	B	L	I	Ağırlık (g) / Weight (g)		Sipariş Kodu / Order code
mm	inch	mm/inch					Çelik Steel	Pirinç Brass	
6		G1/8H	17	14	24	8	30	34	CS11-120-0671
8		G1/4H	19	19	26	10	40	46	CS11-120-0872
10		G1/4H	22	19	28	10	50	57	CS11-120-1072
12		G3/8H	24	22	30	12	65	74	CS11-120-1273
14		G3/8H	27	24	30	12	60	69	CS11-120-1473
15		G3/8H	27	24	33	12	65	74	CS11-120-1573
16		G3/8H	30	27	32	12	95	109	CS11-120-1673
18		G1/2H	30	27	35	13.5	100	115	CS11-120-1874
20		G1/2H	32	30	36	12.5	100	115	CS11-120-2074
22		G1/2H	36	36	36	12.5	125	143	CS11-120-2274
25		G3/4H	41	36	37	14	200	230	CS11-120-2575
28		G1" H	46	41	41	18.5	230	264	CS11-120-2876
30		G1" H	46	46	44	1.5	230	264	CS11-120-3076
35		G1" 1/4H	50	50	48	20.5	320	368	CS11-120-3577
38		G1" 1/4H	55	50	48	20.5	350	402	CS11-120-3877
40		G1" 1/2H	60	60	48	21.5	640	736	CS11-120-4078
44.5		G1" 1/2H	65	65	51	21.5	652	749	CS11-120-4478

10.2	1/8	G1/4H	22	19	29	10	50	57	CS11-110-7172
13.5	1/4	G1/4H	27	24	28	10	75	86	CS11-110-7272
17.2	3/8	G3/8H	30	27	32	12	110	126	CS11-110-7373
21.3	1/2	G1/2H	36	32	35	12.5	165	189	CS11-110-7474
26.9	3/4	G3/4H	46	41	37	13.5	195	224	CS11-110-7575
33.7	1"	G1" H	50	46	44	17	315	362	CS11-110-7676
42.4	1" 1/4	G1" 1/4H	65	60	49	17.5	602	692	CS11-110-7777
48.3	1" 1/2	G1" 1/2H	70	65	52	18.5	710	816	CS11-110-7878
60.3	2"	G2" H	85	80	59	20	930	1069	CS11-110-7979

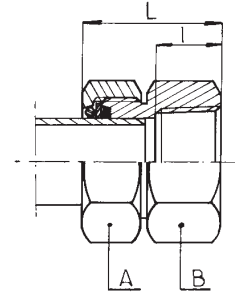

Yukarıda listelenen sipariş kodları standart bağlantı parçaları içindir. Diğer malzemeler, boyutlar ve ekipman istek üzerine gerçekleştirilebilir.  
The above listed order codes are for standard fittings. Other materials, sizes and equipment can be realised on request.

**UF**

CS11 Serisi / CS11 Series

**Paralel Kadın Birliği ISO / Parallel Female Union ISO**

Tüp O.D Tube O.D			A	B	L	I	Ağırlık (g) Weight (g)		Sipariş Kodu Order code Çelik Steel
mm	inch	mm/inch					Çelik Steel	Pirinç Brass	
6		M10X100	17	14	23.5	8	30	34	CS11-120-0610
8		M12X100	19	17	23.5	8	40	46	CS11-120-0812
10		M14X150	22	19	28	10	50	57	CS11-120-1014
12		M16X150	24	22	28	10	65	74	CS11-120-1216
14		M18X150	27	24	30	12	60	69	CS11-120-1418
15		M18X150	27	24	31.5	12	65	74	CS11-120-1518
16		M20X150	30	27	32	12	95	109	CS11-120-1620
18		M22X150	30	30	34	13	100	115	CS11-120-1822
20		M24X150	32	32	34	13	100	115	CS11-120-2024
22		M24X150	36	36	35	13	125	143	CS11-120-2224
25		M30X150	41	41	37	15	200	230	CS11-120-2530
28		M33X200	46	41	39	16	230	264	CS11-120-2833
30		M33X200	46	46	41	16	230	264	CS11-120-3033
35		M39X200	50	46	45	17	295	339	CS11-120-3539
38		M42X200	55	50	44	17	350	402	CS11-120-3842
40		M45X200	60	55	49	17	425	488	CS11-120-4045
44.5		M48X200	65	65	51	17	500	575	CS11-120-4448

10.2	1/8	M14X150	22	19	28	10	50	57	CS11-110-7114
13.5	1/4	M18X150	27	24	30	12	75	86	CS11-110-7218
17.2	3/8	M20X150	30	27	32	12	110	126	CS11-110-7320
21.3	1/2	M24X150	36	32	34	13	165	189	CS11-110-7424
26.9	3/4	M30X150	46	41	37	15	195	224	CS11-110-7530
33.7	1"	M39X200	50	46	42	17	315	362	CS11-110-7639
42.4	1" 1/4	M45X200	65	60	45	17	602	692	CS11-110-7745
48.3	1" 1/2	M48X200	70	65	47	15.5	710	816	CS11-110-7848
60.3	2"	M60X200	85	80	55	15.5	930	1069	CS11-110-7960

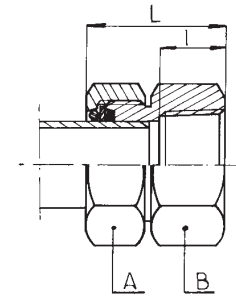

Yukarıda listelenen sipariş kodları standart bağlantı parçaları içindir. Diğer malzemeler, boyutlar ve ekipman istek üzerine gerçekleştirilebilir.  
The above listed order codes are for standard fittings. Other materials, sizes and equipment can be realised on request.

UFN

CS12 Serisi / CS12 Series

Konik Dişi Rakor NPT / Taper Female Union NPT									
Tüp O.D Tube O.D			A	B	L	I	Ağırlık (g) Weight (g)		Sipariş Kodu Order code Çelik Steel
mm	inch	mm/inch					Çelik Steel	Pirinç Brass	
6		N1/8	17	14	24	8	35	40	CS12-120-0671
8		N1/4	19	17	30.5	12	45	51	CS12-120-0872
10		N1/4	22	19	29	12	55	63	CS12-120-1072
12		N3/8	24	22	30.5	12	65	74	CS12-120-1273
14		N3/8	27	24	30.5	12	80	92	CS12-120-1473
15		N3/8	27	24	31.5	11.5	88	101	CS12-120-1573
16		N3/8	30	27	32	11.5	100	115	CS12-120-1673
18		N1/2	30	27	37	16	90	103	CS12-120-1874
20		N1/2	32	30	38	15	120	138	CS12-120-2074
22		N1/2	36	36	39	15	130	149	CS12-120-2274
25		N3/4	41	36	38	15	180	207	CS12-120-2575
28		N1"	46	41	43	20	235	270	CS12-120-2876
30		N1"	46	46	45.5	18.5	300	345	CS12-120-3076
35		N1"1/4	50	50	49	20	370	425	CS12-120-3577
38		N1"1/4	55	50	47	20	360	414	CS12-120-3877
40		N1"1/2	60	55	50	22	435	500	CS12-120-4078
44.5		N1"1/2	65	65	51	22	520	598	CS12-120-4478

10.2	1/8	N1/4	22	19	29	12	60	69	CS12-110-7172
13.5	1/4	N1/4	27	24	30.5	11.5	80	92	CS12-110-7272
17.2	3/8	N3/8	30	27	32	11.5	100	115	CS12-110-7373
21.3	1/2	N1/2	36	32	37	15	150	172	CS12-110-7474
26.9	3/4	N3/4	46	41	38	14.5	260	299	CS12-110-7575
33.7	1"	N1"	50	46	45.5	19	300	345	CS12-110-7676
42.4	1" 1/4	N1"1/4	65	60	48	17	575	661	CS12-110-7777
48.3	1"1/2	N1"1/2	70	65	52	19	710	816	CS12-110-7878
60.3	2"	N2"	85	80	57	18.5	975	1121	CS12-110-7979

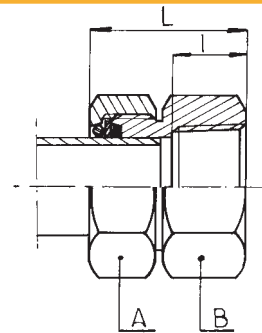

Yukarıda listelenen sipariş kodları standart bağlantı parçaları içindir. Diğer malzemeler, boyutlar ve ekipman istek üzerine gerçekleştirilebilir.

The above listed order codes are for standard fittings. Other materials, sizes and equipment can be realised on request.

**AM**

CS13 Serisi / CS13 Series

**Paralel Erkek Gövde Adaptörü BSPP / Parallel Male Stem Adaptor BSPP**

Tüp O.D Tube O.D			B	LA	L	I	Ağırlık (g) Weight (g)		Sipariş Kodu Order code Çelik Steel
mm	inch	mm/inch					Çelik Steel	Pirinç Brass	
6		G1/8B	17	16	28	6	15	17	CS13-109-0671
8		G1/4B	19	18	33	8	20	23	CS13-109-0872
10		G1/4B	22	18	33	8	25	28	CS13-109-1072
12		G3/8B	24	20	35	8	30	34	CS13-109-1273
14		G3/8B	27	20	35	8	35	40	CS13-109-1473
15		G3/8B	27	22	37	8	40	46	CS13-109-1573
16		G3/8B	30	22	37	10	40	46	CS13-109-1673
18		G1/2B	30	24	43	10	80	92	CS13-109-1874
20		G1/2B	32	26	45	10	85	97	CS13-109-2074
22		G1/2B	36	28	47	10	90	103	CS13-109-2274
25		G3/4B	41	30	53	14	100	115	CS13-109-2575
28		G1" B	46	30	55	14	130	149	CS13-109-2876
30		G1" B	46	32	57	14	145	166	CS13-109-3076
35		G1" 1/4B	50	34	66	16	295	339	CS13-109-3577
38		G1" 1/4B	55	36	68	16	300	345	CS13-109-3877
40		G1" 1/2B	60	36	68	16	430	494	CS13-109-4078
44.5		G1" 1/2B	65	40	72	16	445	511	CS13-109-4478

10.2	1/8	G1/4B	22	18	33	8	25	28	CS13-109-7172
13.5	1/4	G1/4B	22	20	35	8	35	40	CS13-109-7272
17.2	3/8	G3/8B	24	24	39	8	45	51	CS13-109-7373
21.3	1/2	G1/2B	32	26	45	10	90	103	CS13-109-7474
26.9	3/4	G3/4B	36	30	53	14	120	138	CS13-109-7575
33.7	1"	G1" B	46	34	59	14	170	195	CS13-109-7676
42.4	1" 1/4	G1" 1/4B	60	40	72	16	423	486	CS13-109-7777
48.3	1" 1/2	G1" 1/2B	65	42	74	16	475	546	CS13-109-7878
60.3	2"	G2" B	75	49	83	18	715	822	CS13-109-7979

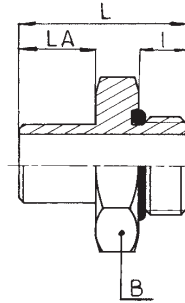

Yukarıda listelenen sipariş kodları standart bağlantı parçaları içindir. Diğer malzemeler, boyutlar ve ekipman istek üzerine gerçekleştirilebilir.  
The above listed order codes are for standard fittings. Other materials, sizes and equipment can be realised on request.

AM

CS13 Serisi / CS13 Series

Paralel Erkek Gövde Adaptörü ISO / Parallel Male Stem Adaptor ISO

Tüp O.D Tube O.D			B	LA	L	I	Ağırlık (g) Weight (g)		Sipariş Kodu Order code Çelik Steel
mm	inch	mm/inch					Çelik Steel	Pirinç Brass	
6		M10X100	17	16	29	7	15	17	CS13-109-0610
8		M12X100	19	18	32	7	20	23	CS13-109-0812
10		M14X150	22	18	34	9	20	23	CS13-109-1014
12		M16X150	24	20	36	9	25	28	CS13-109-1216
14		M18X150	27	20	38	11	25	28	CS13-109-1418
15		M18X150	27	22	40	11	35	40	CS13-109-1518
16		M20X150	30	22	41	11	45	51	CS13-109-1620
18		M22X150	30	24	45	12	65	74	CS13-109-1822
20		M24X150	32	26	47	12	95	109	CS13-109-2024
22		M27X150	36	28	51	14	100	115	CS13-109-2227
25		M30X150	41	30	54	14	140	161	CS13-109-2530
28		M33X200	46	30	56	15	150	172	CS13-109-2833
30		M33X200	46	32	58	15	160	184	CS13-109-3033
35		M39X200	50	34	62	16	202	232	CS13-109-3539
38		M42X200	55	36	68	16	370	425	CS13-109-3842
40		M45X200	60	36	68	16	370	425	CS13-109-4045
44.5		M48X200	65	40	72	16	450	517	CS13-109-4448

10.2	1/8	M14X150	22	18	32	9	18	20	CS13-109-7114
13.5	1/4	M18X150	27	20	38	11	35	40	CS13-109-7218
17.2	3/8	M20X150	27	24	43	11	50	57	CS13-109-7320
21.3	1/2	M24X150	36	26	47	12	100	115	CS13-109-7424
26.9	3/4	M30X150	41	30	54	14	140	161	CS13-109-7530
33.7	1"	M39X200	50	34	62	16	205	235	CS13-109-7639
42.4	1" 1/4	M45X200	60	40	72	16	470	540	CS13-109-7745
48.3	1" 1/2	M48X200	65	42	74	16	475	546	CS13-109-7848
60.3	2	M60X200	80	49	83	20	745	856	CS13-109-7960

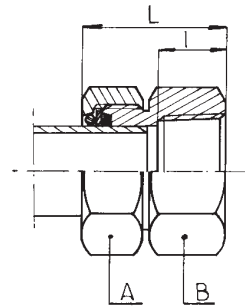

Yukarıda listelenen sipariş kodları standart bağlantı parçaları içindir. Diğer malzemeler, boyutlar ve ekipman istek üzerine gerçekleştirilebilir.

The above listed order codes are for standard fittings. Other materials, sizes and equipment can be realised on request.

# AMC

CS14 Serisi / CS14 Series

## Paralel Erkek Gövde Adaptörü BSPT / Taper Male Stem Adaptor BSPT

Tüp O.D Tube O.D			B	LA	L	I	Ağırlık (g) Weight (g)		Sipariş Kodu Order code Çelik Steel
mm	inch	mm/inch					Çelik Steel	Pirinç Brass	
6		G1/8	12	16	31	9.5	10	11	CS14-009-0671
8		G1/4	14	18	36	12.5	15	17	CS14-009-0872
10		G1/4	14	18	36	12.5	15	17	CS14-009-1072
12		G3/8	19	20	38	12.5	25	28	CS14-009-1273
14		G3/8	19	20	38	12.5	25	28	CS14-009-1473
15		G3/8	19	22	40	12.5	30	34	CS14-009-1573
16		G3/8	19	22	40	12.5	35	40	CS14-009-1673
18		G1/2	22	24	49	17.5	50	57	CS14-009-1874
20		G1/2	22	26	51	17.5	55	63	CS14-009-2074
22		G1/2	24	28	53	17.5	55	63	CS14-009-2274
25		G3/4	30	30	58	19	125	143	CS14-009-2575
28		G1"	36	30	60	21	130	149	CS14-009-2876
30		G1"	36	32	62	21	160	184	CS14-009-3076
35		G1"1/4	46	34	69	24	200	230	CS14-009-3577
38		G1"1/4	46	36	71	24	292	335	CS14-009-3877
40		G1"1/2	50	36	72	24	385	442	CS14-009-4078
44.5		G1"1/2	50	40	76	24	420	483	CS14-009-4478

10.2	1/8	G1/4	14	18	36	12.5	15	17	CS14-009-7172
13.5	1/4	G1/4	14	20	38	12.5	15	17	CS14-009-7272
17.2	3/8	G3/8	19	24	42	12.5	35	40	CS14-009-7373
21.3	1/2	G1/2	22	26	51	17.5	60	69	CS14-009-7474
26.9	3/4	G3/4	30	30	58	19	144	165	CS14-009-7575
33.7	1"	G1"	36	34	64	21	211	242	CS14-009-7676
42.4	1" 1/4	G1"1/4	46	40	75	24	386	443	CS14-009-7777
48.3	1"1/2	G1"1/2	50	42	78	24	494	568	CS14-009-7878
60.3	2	G2"	65	49	92	27	906	1041	CS14-009-7979

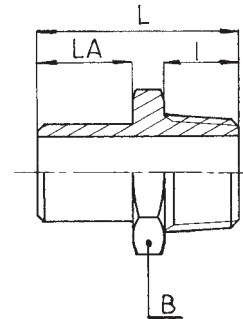

Yukarıda listelenen sipariş kodları standart bağlantı parçaları içindir. Diğer malzemeler, boyutlar ve ekipman istek üzerine gerçekleştirilebilir.  
The above listed order codes are for standard fittings. Other materials, sizes and equipment can be realised on request.

AMN

CS15 Serisi / CS15 Series

Paralel Erkek Gövde Adaptörü NPT / Taper Male Stem Adaptor NPT

Tüp O.D mm	Tube O.D inch mm/inch		B	LA	L	I	Ağırlık (g) Weight (g)		Sipariş Kodu Order code Çelik Steel
	inch	mm/inch					Çelik Steel	Pirinç Brass	
6		N1/8	12	16	29.5	8	10	11	CS15-009-0671
8		N1/4	17	18	35.5	12	20	23	CS15-009-0872
10		N1/4	17	18	35.5	12	20	23	CS15-009-1072
12		N3/8	19	20	37.5	12	25	28	CS15-009-1273
14		N3/8	19	20	37.5	12	25	28	CS15-009-1473
15		N3/8	19	22	39.5	12	27	31	CS15-009-1573
16		N3/8	19	22	39.5	12	35	40	CS15-009-1673
18		N1/2	24	24	47	16	60	69	CS15-009-1874
20		N1/2	24	26	49	16	65	74	CS15-009-2074
22		N1/2	24	28	51	16	70	80	CS15-009-2274
25		N3/4	30	30	55	16	100	115	CS15-009-2575
28		N1"	36	30	59	20	100	115	CS15-009-2876
30		N1"	36	32	61	20	135	155	CS15-009-3076
35		N1"1/4	46	34	65	20	195	224	CS15-009-3577
38		N1"1/4	46	36	67	20	200	230	CS15-009-3877
40		N1"1/2	50	36	70	22	255	293	CS15-009-4078
44.5		N1"1/2	50	40	74	22	330	379	CS15-009-4478

10.2	1/8	N1/4	17	18	35.5	12	20	23	CS15-009-7172
13.5	1/4	N1/4	17	20	37.5	12	20	23	CS15-009-7272
17.2	3/8	N3/8	19	24	41.5	12	35	40	CS15-009-7373
21.3	1/2	N1/2	24	26	49	16	70	80	CS15-009-7474
26.9	3/4	N3/4	30	30	55	16	105	120	CS15-009-7575
33.7	1"	N1"	36	34	63	20	160	184	CS15-009-7676
42.4	1" 1/4	N1"1/4	46	40	71	20	270	310	CS15-009-7777
48.3	1"1/2	N1"1/2	50	42	76	22	340	391	CS15-009-7878
60.3	2	N2"	65	49	87	22	899	1033	CS15-009-7979

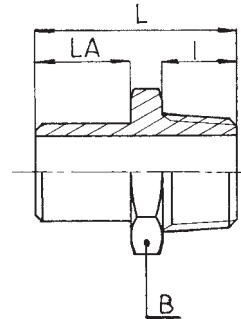

Yukarıda listelenen sipariş kodları standart bağlantı parçaları içindir. Diğer malzemeler, boyutlar ve ekipman istek üzerine gerçekleştirilebilir.

The above listed order codes are for standard fittings. Other materials, sizes and equipment can be realised on request.



**AF**

CS16 Serisi / CS16 Series

**Paralel Dişi Gövde Adaptörü BSP / Parallel Female Stem Adaptor BSP**

Tüp O.D Tube O.D			B	LA	H	I	Ağırlık (g) Çelik Steel	Weight (g) Pirinç Brass	Sipariş Kodu Order code Çelik Steel
mm	inch	mm/inch							
6		G1/8H	14	16	13	8	15	17	CS16-009-0671
8		G1/4H	19	18	15	10	35	40	CS16-009-0872
10		G1/4H	19	18	15	10	30	34	CS16-009-1072
12		G3/8H	22	20	17	12	50	57	CS16-009-1273
14		G3/8H	22	20	17	12	50	57	CS16-009-1473
15		G3/8H	22	22	17	12	60	69	CS16-009-1573
16		G3/8H	22	22	17	12	65	74	CS16-009-1673
18		G1/2H	27	24	19.5	13.5	75	86	CS16-009-1874
20		G1/2H	27	26	19.5	13.5	80	92	CS16-009-2074
22		G1/2H	27	28	19.5	13.5	85	97	CS16-009-2274
25		G3/4H	32	30	21	15	95	109	CS16-009-2575
28		G1"H	41	30	25.5	18.5	225	258	CS16-009-2876
30		G1"H	41	32	25.5	18.5	200	230	CS16-009-3076
35		G1"1/4H	50	34	29.5	20.5	300	345	CS16-009-3577
38		G1"1/4H	50	36	29.5	20.5	305	350	CS16-009-3877
40		G1"1/2H	60	36	30.5	21.5	460	529	CS16-009-4078
44.5		G1"1/2H	60	40	30.5	21.5	540	621	CS16-009-4478

10.2	1/8	G1/4H	19	18	15	10	29	33	CS16-009-7172
13.5	1/4	G1/4H	19	20	15	10	35	40	CS16-009-7272
17.2	3/8	G3/8H	22	24	17	12	55	63	CS16-009-7373
21.3	1/2	G1/2H	27	26	19.5	13.5	75	86	CS16-009-7474
26.9	3/4	G3/4H	32	30	21	15	90	103	CS16-009-7575
33.7	1"	G1"H	41	34	25.5	18.5	185	212	CS16-009-7676
42.4	1" 1/4	G1"1/4H	50	40	29.5	20.5	280	322	CS16-009-7777
48.3	1"1/2	G1"1/2H	60	42	30.5	21.5	470	540	CS16-009-7878
60.3	2"	G2"H	70	49	35.5	23.5	790	908	CS16-009-7979

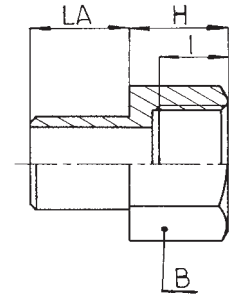

Yukarıda listelenen sipariş kodları standart bağlantı parçaları içindir. Diğer malzemeler, boyutlar ve ekipman istek üzerine gerçekleştirilebilir.  
The above listed order codes are for standard fittings. Other materials, sizes and equipment can be realised on request.

AF

CS16 Serisi / CS16 Series

Paralel Dişi Gövde Adaptörü ISO / Parallel Female Stem Adaptor ISO

Tüp O.D	Tube O.D		B	LA	H	I	Ağırlık (g)		Sipariş Kodu Order code
	mm	inch					mm/inch	Çelik Steel	
6		M10X100	14	16	12	8	15	17	CS16-009-0610
8		M12X100	17	18	12	8	20	23	CS16-009-0812
10		M14X150	19	18	15	10	30	34	CS16-009-1014
12		M16X150	22	20	15	10	40	46	CS16-009-1216
14		M18X150	24	20	17	12	50	57	CS16-009-1418
15		M18X150	24	22	17	12	60	69	CS16-009-1518
16		M20X150	27	22	18	12	70	80	CS16-009-1620
18		M22X150	30	24	19	13	85	97	CS16-009-1822
20		M24X150	32	26	19	13	95	109	CS16-009-2024
22		M24X150	32	28	19	13	130	149	CS16-009-2224
25		M30X150	41	30	21	15	190	218	CS16-009-2530
28		M33X200	41	30	23	16	175	201	CS16-009-2833
30		M33X200	41	32	23	16	175	201	CS16-009-3033
35		M39X200	46	34	25	17	230	264	CS16-009-3539
38		M42X200	50	36	26	17	275	316	CS16-009-3842
40		M45X200	55	36	26	17	340	391	CS16-009-4045
44.5		M48X200	60	40	27	17	545	626	CS16-009-4448

10.2	1/8	M14X150	19	18	15	10	29	33	CS16-009-7114
13.5	1/4	M18X150	24	20	17	12	50	57	CS16-009-7218
17.2	3/8	M20X150	27	24	18	12	67	77	CS16-009-7320
21.3	1/2	M24X150	32	26	19	13	100	115	CS16-009-7424
26.9	3/4	M30X150	41	30	21	15	185	212	CS16-009-7530
33.7	1"	M39X200	46	34	25	17	230	264	CS16-009-7639
42.4	1" 1/4	M45X200	55	40	26	17	350	402	CS16-009-7745
48.3	1" 1/2	M48X200	60	42	27	17	450	517	CS16-009-7848
60.3	2"	M60X200	70	49	31	19	680	782	CS16-009-7960

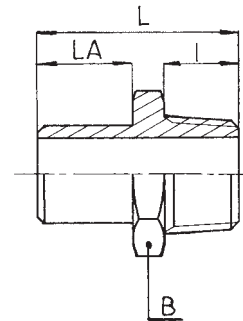

Yukarıda listelenen sipariş kodları standart bağlantı parçaları içindir. Diğer malzemeler, boyutlar ve ekipman istek üzerine gerçekleştirilebilir.

The above listed order codes are for standard fittings. Other materials, sizes and equipment can be realised on request.

# AFN

CS17 Serisi / CS17 Series

## Konik Dişi Gövde Adaptörü NPT / Taper Female Stem Adaptor NPT

Tüp O.D Tube O.D			B	LA	H	I	Ağırlık (g) Weight (g)		Sipariş Kodu Order code Çelik Steel
mm	inch	mm/inch					Çelik Steel	Pirinç Brass	
6		N1/8	12	16	13	8	15	17	CS17-009-0671
8		N1/4	17	18	17	12	40	46	CS17-009-0872
10		N1/4	17	18	17	12	40	46	CS17-009-1072
12		N3/8	22	20	17	12	55	63	CS17-009-1273
14		N3/8	22	20	17	12	55	63	CS17-009-1473
15		N3/8	22	22	17	12	58	66	CS17-009-1573
16		N3/8	22	22	17	12	60	69	CS17-009-1673
18		N1/2	27	24	22	16	80	92	CS17-009-1874
20		N1/2	27	26	22	16	85	97	CS17-009-2074
22		N1/2	27	28	22	16	90	103	CS17-009-2274
25		N3/4	32	30	22	16	125	143	CS17-009-2575
28		N1"	41	30	27	20	175	201	CS17-009-2876
30		N1"	41	32	27	20	200	230	CS17-009-3076
35		N1"1/4	50	34	29	20	314	361	CS17-009-3577
38		N1"1/4	50	36	29	20	400	460	CS17-009-3877
40		N1"1/2	55	36	31	22	455	523	CS17-009-4078
44.5		N1"1/2	55	40	31	22	395	454	CS17-009-4478

10.2	1/8	N1/4	17	18	17	12	38	43	CS17-009-7172
13.5	1/4	N1/4	17	20	17	12	40	46	CS17-009-7272
17.2	3/8	N3/8	22	24	17	12	45	51	CS17-009-7373
21.3	1/2	N1/2	27	26	22	16	80	92	CS17-009-7474
26.9	3/4	N3/4	32	30	22	16	125	143	CS17-009-7575
33.7	1"	N1"	41	34	27	20	195	224	CS17-009-7676
42.4	1" 1/4	N1"1/4	50	40	29	20	365	419	CS17-009-7777
48.3	1"1/2	N1"1/2	55	42	31	22	455	523	CS17-009-7878
60.3	2"	N2"	70	49	34	22	940	1081	CS17-009-7979

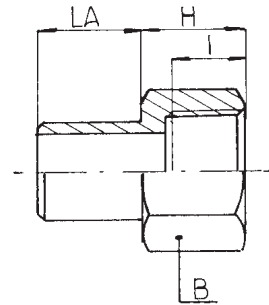

Yukarıda listelenen sipariş kodları standart bağlantı parçaları içindir. Diğer malzemeler, boyutlar ve ekipman istek üzerine gerçekleştirilebilir.  
The above listed order codes are for standard fittings. Other materials, sizes and equipment can be realised on request.

AUR

CS18 Serisi / CS18 Series

Redüksiyon Rakor Adaptörü / Reducing Union Adaptor

Tüp O.D		Tube O.D		A	B	L	LA	H	LT	Ağırlık (g) Çelik Steel	Weight (g) Pirinç Brass	Sipariş Kodu Order code Çelik Steel
mm	inch	mm	inch									
8		6		17	14	37	18	5.5	16	28	32	CS18-120-0806
10		8		19	17	37	18	5.5	16	32	36	CS18-120-1008
12		10		22	19	41	20	5.5	18	48	55	CS18-120-1210
14		12		24	22	43	20	7	19	58	66	CS18-120-1412
15		12		24	22	46	22	7	19	66	75	CS18-120-1512
16		14		27	24	44	22	7	19	104	119	CS18-120-1614
18		16		30	27	48	24	7	21	120	138	CS18-120-1816
20		18		30	27	52	26	7	22	110	126	CS18-120-2018
22		20		32	30	56	28	9	23	141	162	CS18-120-2220
25		22		36	36	59	30	9	24	197	226	CS18-120-2522
28		25		41	36	58	30	9	23	188	216	CS18-120-2825
30		28		46	41	61	32	10	24	272	312	CS18-120-3028
35		32		50	46	67	34	11	27	340	391	CS18-120-3532
38		30		46	46	69	36	11	27	361	415	CS18-120-3830
44.5		38		55	50	75	40	12	29	437	502	CS18-120-4438

17.2	3/8	13.5	1/4	27	24	47	24	7	19	91	104	CS18-110-7372
21.3	1/2	17.2	3/8	30	27	51	26	7	21	121	139	CS18-110-7473
26.9	3/4	21.3	1/2	36	32	58	30	9	23	189	217	CS18-110-7574
33.7	1"	16.9	3/4	46	41	63	34	10	24	328	377	CS18-110-7675
42.4	1" 1/4	33.7	1"	50	46	73	40	11	27	437	502	CS18-110-7776
48.3	1" 1/2	42.4	1" 1/4	65	60	81	42	16	31	696	800	CS18-110-7877
60.3	2	48.3	1" 1/2	70	65	91	49	16	33	1063	1222	CS18-110-7978

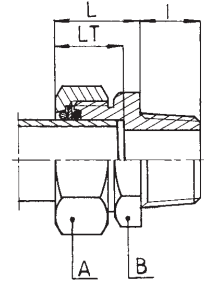

Yukarıda listelenen sipariş kodları standart bağlantı parçaları içindir. Diğer malzemeler, boyutlar ve ekipman istek üzerine gerçekleştirilebilir.

The above listed order codes are for standard fittings. Other materials, sizes and equipment can be realised on request.

**E**

CS19 Serisi / CS19 Series

**Eşit Dirsek / Equal Elbow**

Tüp O.D Tube O.D			A	B	L	LT	Ağırlık (g) Weight (g)		Sipariş Kodu Order code Çelik Steel
mm	inch	mm/inch					Çelik Steel	Pirinç Brass	
6			17	17	28	21	40	46	CS19-120-0600
8			19	17	28	20	60	69	CS19-120-0800
10			22	17	29	19	80	92	CS19-120-1000
12			24	19	34	23	95	109	CS19-120-1200
14			27	19	34	23	100	115	CS19-120-1400
15			27	24	34	23	125	143	CS19-120-1500
16			30	24	37	24	160	184	CS19-120-1600
18			30	24	38	25	176	202	CS19-120-1800
20			32	30	44	28	195	224	CS19-120-2000
22			36	30	44	26	235	270	CS19-120-2200
25			41	36	47	27	320	368	CS19-120-2500
28			46	36	47	26	447	514	CS19-120-2800
30			46	41	52	30	510	586	CS19-120-3000
35			50	46	57	31	519	596	CS19-120-3500
38			55	50	61	36	847	974	CS19-120-3800
40			60	50	60	29	860	989	CS19-120-4000
44.5			65	60	69	36	886	1018	CS19-120-4400

10.2	1/8		22	17	28	19	78	89	CS19-110-7100
13.5	1/4		27	19	34	23	110	126	CS19-110-7200
17.2	3/8		30	24	38	24	152	174	CS19-110-7300
21.3	1/2		36	30	43	25	225	258	CS19-110-7400
26.9	3/4		46	36	47	26	390	448	CS19-110-7500
33.7	1"		50	46	56	35	494	568	CS19-110-7600
42.4	1" 1/4		65	50	61	30	1002	152	CS19-110-7700
48.3	1" 1/2		70	60	69	36	1166	1340	CS19-110-7800
60.3	2"		85	70	80	47	2494	2868	CS19-110-7900

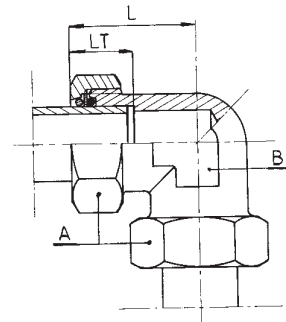

Yukarıda listelenen sipariş kodları standart bağlantı parçaları içindir. Diğer malzemeler, boyutlar ve ekipman istek üzerine gerçekleştirilebilir.  
The above listed order codes are for standard fittings. Other materials, sizes and equipment can be realised on request.

T

CS20 Serisi / CS20 Series

Eşit Te / Equal Tee									
Tüp O.D	Tube O.D		A	B	L	LT	Ağırlık (g)		Sipariş Kodu
	mm	inch					mm/inch	Çelik Steel	
6			17	17	28	21	60	69	CS20-120-0600
8			19	17	28	20	75	86	CS20-120-0800
10			22	17	29	19	95	109	CS20-120-1000
12			24	19	34	23	130	149	CS20-120-1200
14			27	19	34	23	150	172	CS20-120-1400
15			27	24	34	23	180	207	CS20-120-1500
16			30	24	37	24	200	230	CS20-120-1600
18			30	24	38	25	229	263	CS20-120-1800
20			32	30	44	28	235	270	CS20-120-2000
22			36	30	44	26	295	339	CS20-120-2200
25			41	36	47	27	445	511	CS20-120-2500
28			46	36	47	26	633	727	CS20-120-2800
30			46	41	52	30	750	862	CS20-120-3000
35			50	46	57	31	800	920	CS20-120-3500
38			55	50	61	36	948	1090	CS20-120-3800
40			60	50	60	29	1050	1207	CS20-120-4000
44.5			65	60	69	36	1144	1315	CS20-120-4400

10.2	1/8		22	17	28	19	93	106	CS20-110-7100
13.5	1/4		27	19	34	23	160	184	CS20-110-7200
17.2	3/8		30	24	38	24	211	242	CS20-110-7300
21.3	1/2		36	30	43	25	302	347	CS20-110-7400
26.9	3/4		46	36	47	26	550	632	CS20-110-7500
33.7	1"		50	46	56	35	663	762	CS20-110-7600
42.4	1" 1/4		65	50	61	30	1358	1561	CS20-110-7700
48.3	1" 1/2		70	60	69	36	1474	1695	CS20-110-7800
60.3	2		85	70	80	47	2991	3439	CS20-110-7900

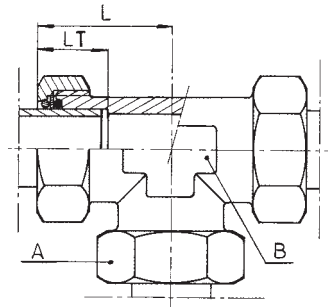

Yukarıda listelenen sipariş kodları standart bağlantı parçaları içindir. Diğer malzemeler, boyutlar ve ekipman istek üzerine gerçekleştirilebilir.

The above listed order codes are for standard fittings. Other materials, sizes and equipment can be realised on request.

**C**

CS21 Serisi / CS21 Series

**Eşit Köşe / Equal Cross**

Tüp O.D Tube O.D			A	B	L	LT	Ağırlık (g) Weight (g)		Sipariş Kodu Order code Çelik Steel
mm	inch	mm/inch					Çelik Steel	Pirinç Brass	
6			17	17	28	21	75	86	CS21-120-0600
8			19	17	28	20	115	132	CS21-120-0800
10			22	17	29	19	150	172	CS21-120-1000
12			24	19	34	23	175	201	CS21-120-1200
14			27	19	34	23	190	218	CS21-120-1400
15			27	24	34	23	45	281	CS21-120-1500
16			30	24	37	24	303	348	CS21-120-1600
18			30	24	38	25	337	387	CS21-120-1800
20			32	30	44	28	360	414	CS21-120-2000
22			36	30	44	26	440	506	CS21-120-2200
25			41	36	47	27	600	690	CS21-120-2500
28			46	36	47	26	811	932	CS21-120-2800
30			46	41	52	30	980	1127	CS21-120-3000
35			50	46	57	31	1220	1403	CS21-120-3500
38			55	50	61	36	1548	1780	CS21-120-3800
40			60	50	60	29	1660	1909	CS21-120-4000
44.5			65	60	69	36	1807	2078	CS21-120-4400

10.2	1/8		22	17	28	19	147	169	CS21-110-7100
13.5	1/4		27	19	34	23	200	230	CS21-110-7200
17.2	3/8		30	24	38	24	302	347	CS21-110-7300
21.3	1/2		36	30	43	25	430	494	CS21-110-7400
26.9	3/4		46	36	47	26	755	868	CS21-110-7500
33.7	1"		50	46	56	35	940	1081	CS21-110-7600
42.4	1" 1/4		65	50	61	30	1929	2218	CS21-110-7700
48.3	1" 1/2		70	60	69	36	2232	2566	CS21-110-7800
60.3	2"		85	70	80	47	4579	5265	CS21-110-7900

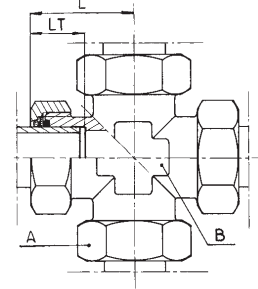

Yukarıda listelenen sipariş kodları standart bağlantı parçaları içindir. Diğer malzemeler, boyutlar ve ekipman istek üzerine gerçekleştirilebilir.  
The above listed order codes are for standard fittings. Other materials, sizes and equipment can be realised on request.

Y

CS22 Serisi / CS22 Series

Eşit Y Kolu / Equal Y Branch												
Tüp O.D mm	Tube O.D inch	A	B	L	LT	a°	I	E	Ağırlık (g)		Sipariş Kodu Order code Çelik Steel	
									Çelik Steel	Pirinç Brass		
16		30	24	37	24	36	54	14	298	342	CS22-120-1600	
18		30	24	38	25	36	55	16	301	346	CS22-120-1800	
25		41	41	52	23	36	70	21	1000	1150	CS22-120-2500	
28		46	41	52	24	36	70	24	1078	1239	CS22-120-2800	
30		46	41	53	24.5	36	71	26	1013	1164	CS22-120-3000	
38		55	45	36	25	30	89	34	1245	1431	CS22-120-3800	

17.2	3/8	30	24	38	24	36	54	14	292	335	CS22-110-7300
26.9	3/4	46	41	52	24	36	70	23	1080	1242	CS22-110-7500
33.7	1"	50	41	48	20	36	66	33	910	1046	CS22-110-7600
42.4	1 1/4"	65	45	36	30	30	89	38	1286	1478	CS22-110-7700



Yukarıda listelenen sipariş kodları standart bağlantı parçaları içindir. Diğer malzemeler, boyutlar ve ekipman istek üzerine gerçekleştirilebilir.  
The above listed order codes are for standard fittings. Other materials, sizes and equipment can be realised on request.



**EM**

CS22 Serisi / CS22 Series

**Paralel Erkek Dirsek BSPP / Parallel Male Elbow BSPP**

Tüp O.D mm	Tube O.D inch		A	B	I	H	LV	IB	Ağırlık (g)		Sipariş Kodu Order code Çelik Steel
									Çelik Steel	Pirinç Brass	
6		G1/8B	17	17	6	21	28	7	50	57	CS22-120-0671
8		G1/4B	19	19	8	22	32	12	75	86	CS22-120-0872
10		G1/4B	22	19	8	22	32	11.5	80	92	CS22-120-1072
12		G3/8B	24	24	8	29	36	15.5	115	132	CS22-120-1273
14		G3/8B	27	24	8	29	36	15	120	138	CS22-120-1473
15		G3/8B	27	24	8	29	37	11	166	190	CS22-120-1573
16		G3/8B	30	24	8	29	36	13	120	138	CS22-120-1673
18		G1/2B	30	30	10	32.5	43	18.5	170	195	CS22-120-1874
20		G1/2B	32	30	10	32.5	44	15	195	224	CS22-120-2074
22		G1/2B	36	30	10	32.5	44	18	205	235	CS22-120-2274
25		G3/4B	41	36	14	35	47	20	320	368	CS22-120-2575
28		G1" B	46	46	14	41	54	27.5	460	529	CS22-120-2876
30		G1" B	46	46	14	41	55	27	455	523	CS22-120-3076
35		G1" 1/4 B	50	50	16	48	61	34	750	862	CS22-120-3577
38		G1" 1/4 B	55	50	16	48	61	25	720	828	CS22-120-3877
40		G1" 1/2 B	60	60	16	53	66	34	1040	1196	CS22-120-4078

10.2	1/8	G1/4B	22	19	8	22	32	11.5	80	92	CS22-110-7172
13.5	1/4	G1/4B	27	19	8	22	34	11	80	92	CS22-110-7272
17.2	3/8	G3/8B	30	24	8	29	38	14	125	143	CS22-110-7373
21.3	1/2	G1/2B	36	30	10	32.5	43	18	205	235	CS22-110-7474
26.9	3/4	G3/4B	46	36	14	35	47	21	295	339	CS22-110-7575
33.7	1"	G1" B	50	46	14	41	56	21	470	540	CS22-110-7676
42.4	1" 1/4	G1" 1/4 B	65	50	16	48	61	31	825	948	CS22-110-7777

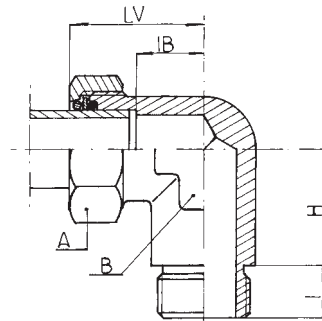

Yukarıda listelenen sipariş kodları standart bağlantı parçaları içindir. Diğer malzemeler, boyutlar ve ekipman istek üzerine gerçekleştirilebilir.  
The above listed order codes are for standard fittings. Other materials, sizes and equipment can be realised on request.

EM

CS22 Serisi / CS22 Series

Paralel Erkek Dirsek ISO / Parallel Male Elbow ISO

Tüp O.D Tube O.D		A	B	I	H	LV	IB	Ağırlık (g) Weight (g)		Sipariş Kodu Order code Çelik Steel	
mm	inch							Çelik Steel	Pirinç Brass		
6		M10X100	17	17	7	20	28	7	50	57	CS22-120-0610
8		M12X100	19	19	7	23	32	12	65	74	CS22-120-0812
10		M14X150	22	19	9	21	32	11.5	75	86	CS22-120-1014
12		M16X150	24	24	9	28	36	15.5	105	120	CS22-120-1216
14		M18X150	27	24	11	26	36	15	130	149	CS22-120-1418
15		M18X150	27	24	11	26	37	11	140	161	CS22-120-1518
16		M20X150	30	30	11	31.5	42	19	240	276	CS22-120-1620
18		M22X150	30	30	12	30.5	43	18.5	200	230	CS22-120-1822
20		M24X150	32	30	12	30.5	44	15	225	258	CS22-120-2024
22		M24X150	36	30	12	30.5	44	18	285	327	CS22-120-2224
25		M30X150	41	36	14	35	47	20	390	448	CS22-120-2530
28		M33X200	46	46	15	40	54	27.5	435	500	CS22-120-2833
30		M33X200	46	46	15	40	55	27	445	511	CS22-120-3033
35		M39X200	50	50	16	48	61	34	765	879	CS22-120-3539
38		M42X200	55	50	16	48	61	25	675	776	CS22-120-3842
40		M45X200	60	50	16	53	66	34	950	1092	CS22-120-4045

10.2	1/8	M14X150	22	19	9	21	32	11.5	75	86	CS22-110-7114
13.5	1/4	M18X150	27	24	11	26	36	15	145	166	CS22-110-7218
17.2	3/8	M20X150	30	30	11	31.5	42	19	155	178	CS22-110-7320
21.3	1/2	M24X150	36	30	12	30.5	43	18	225	258	CS22-110-7424
26.9	3/4	M30X150	46	36	14	35	47	21	370	425	CS22-110-7530
33.7	1"	M39X200	50	50	16	48	59	29	795	914	CS22-110-7639
42.4	1" 1/4	M45X200	65	60	16	53	67.5	31	1045	1201	CS22-110-7745

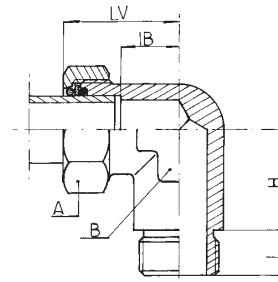

Yukarıda listelenen sipariş kodları standart bağlantı parçaları içindir. Diğer malzemeler, boyutlar ve ekipman istek üzerine gerçekleştirilebilir.

The above listed order codes are for standard fittings. Other materials, sizes and equipment can be realised on request.

**EMC**

CS23 Serisi / CS23 Series

**Konik Erkek Dirsek BSPT / Taper Male Elbow BSPT**

Tüp O.D mm	Tube O.D inch		A	B	I	H	LV	IG	Sipariş Kodu Order code Çelik Steel
6		G1/8	17	17	9.5	18.5	28	7	CS23-120-0671
8		G1/4	19	17	12.5	15.5	28	8	CS23-120-0872
10		G1/4	22	17	12.5	15.5	29	10	CS23-120-1072
12		G3/8	24	19	12.5	18.5	34	11	CS23-120-1273
14		G3/8	27	19	12.5	18.5	34	11	CS23-120-1473
15		G3/8	27	24	12.5	25.5	37	11	CS23-120-1573
16		G3/8	30	24	12.5	25.5	37	13	CS23-120-1673
18		G1/2	30	24	17.5	20.5	38	14	CS23-120-1874
20		G1/2	32	30	17.5	26	44	16	CS23-120-2074
22		G1/2	36	30	17.5	26	44	18	CS23-120-2274
25		G3/4	41	36	19	31	47	20	CS23-120-2575
28		G1"	46	36	21	28	47	21	CS23-120-2876
30		G1"	46	46	21	35	55	27	CS23-120-3076
35		G1"1/4	50	46	24	32	57	26	CS23-120-3577
38		G1"1/4	55	50	24	41	61	25	CS23-120-3877
40		G1"1/2	60	50	24	41	60	31	CS23-120-4078

10.2	1/8	G1/4	22	17	12.5	15.5	28	9	CS23-110-7172
13.5	1/4	G1/4	27	19	12.5	18.5	34	11	CS23-110-7272
17.2	3/8	G3/8	30	24	12.5	25.5	38	14	CS23-110-7373
21.3	1/2	G1/2	36	30	17.5	26	43	18	CS23-110-7474
26.9	3/4	G3/4	46	36	19	31	47	21	CS23-110-7575
33.7	1"	G1"	50	46	21	35	56	21	CS23-110-7676
42.4	1"1/4	G1"1/4	65	50	24	41	61	31	CS23-110-7777

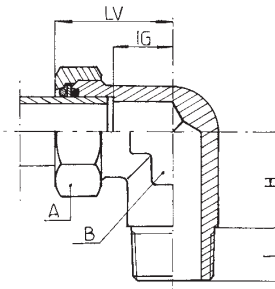

Yukarıda listelenen sipariş kodları standart bağlantı parçaları içindir. Diğer malzemeler, boyutlar ve ekipman istek üzerine gerçekleştirilebilir.  
The above listed order codes are for standard fittings. Other materials, sizes and equipment can be realised on request.

EMN

Konik Erkek Dirsek NPT / Taper Male Elbow NPT

Tüp O.D	Tube O.D		A	B	I	H	LV	IN		Sipariş Kodu
mm	inch									Order code
										Çelik Steel
6		N1/8	17	17	8	19	28	7		CS24-120-0671
8		N1/4	19	19	12	15	28	8		CS24-120-0872
10		N1/4	22	19	12	15	29	10		CS24-120-1072
12		N3/8	24	24	12	18	34	11		CS24-120-1273
14		N3/8	27	24	12	18	34	11		CS24-120-1473
15		N3/8	27	24	12	25	37	11		CS24-120-1573
16		N3/8	30	30	12	25	37	13		CS24-120-1673
18		N1/2	30	30	16	21	38	14		CS24-120-1874
20		N1/2	32	30	16	27	44	16		CS24-120-2074
22		N1/2	36	30	16	27	44	18		CS24-120-2274
25		N3/4	41	36	16	33	47	20		CS24-120-2575
28		N1"	46	46	20	29	47	21		CS24-120-2876
30		N1"	46	46	20	35	55	27		CS24-120-3076
35		N1"1/4	50	50	20	35	57	26		CS24-120-3577
38		N1"1/4	55	50	20	44	61	25		CS24-120-3877
40		N1"1/2	60	50	22	42	60	31		CS24-120-4078

CS24 Serisi / CS24 Series

10.2	1/8	N1/4	22	17	12	15	28	9		CS24-110-7172
13.5	1/4	N1/4	27	19	12	18	34	11		CS24-110-7272
17.2	3/8	N3/8	30	24	12	25	38	14		CS24-110-7373
21.3	1/2	N1/2	36	30	16	27	43	18		CS24-110-7474
26.9	3/4	N3/4	46	36	16	33	47	21		CS24-110-7575
33.7	1"	N1"	50	46	20	35	56	21		CS24-110-7676
42.4	1" 1/4	N1"1/4	65	50	20	44	61	31		CS24-110-7777

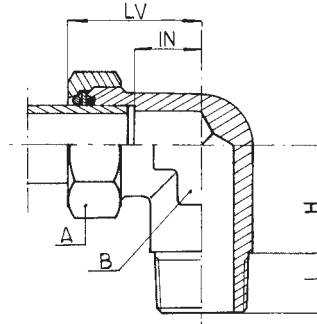

Yukarıda listelenen sipariş kodları standart bağlantı parçaları içindir. Diğer malzemeler, boyutlar ve ekipman istek üzerine gerçekleştirilebilir.

The above listed order codes are for standard fittings. Other materials, sizes and equipment can be realised on request.

**OR**

CS25 Serisi / CS25 Series

**Paralel Tek Banjo BSPP / Parallel Single Banjo BSPP**

Tüp O.D Tube O.D		G	I	C	H	B	HB	K	S	Q	A	Sipariş Kodu Order code Çelik Steel
mm	inch											
6		G1/8B	5.9	27.5	20.5	17	5	13	21	36.5	17	CS25-120-0671
8		G1/4B	7.8	27.5	25.5	22	6	16	20	36.5	19	CS25-120-0872
10		G1/4B	7.8	27.5	25.5	22	6	16	20	37	22	CS25-120-1072
12		G3/8B	7.8	30	29.5	24	6	18	14.5	36	24	CS25-120-1273
14		G3/8B	7.8	30	29.5	24	6	18	18	36	27	CS25-120-1473
16		G3/8B	7.8	30	29.5	24	6	18	17	36.5	30	CS25-120-1673
18		G1/2B	9.6	38	37	30	7	22	17.5	42	30	CS25-120-1874
20		G1/2B	9.6	38	37	30	7	22	18.5	43	32	CS25-120-2074
22		G1/2B	9.6	38	37	30	7	22	18	44	36	CS25-120-2274
25		G3/4B	13.6	50	43	36	9	25.5	27.5	50.5	41	CS25-120-2575
28		G1”B	14.1	50	41	41	9	30	27.5	50.5	46	CS25-120-2876
30		G1”B	14.1	50	51	41	9	30	27	51.5	46	CS25-120-3076

10.2	1/8	G1/4B	7.8	27.5	25.5	22	6	16	18.5	37	22	CS25-110-7172
13.5	1/4	G1/4B	7.8	27.5	25.5	22	6	16	15.5	37.5	27	CS25-110-7272
17.2	3/8	G3/8B	7.8	30	29.5	24	6	18	17	37	30	CS25-110-7373
21.3	1/2	G1/2B	9.6	38	37	30	7	22	18	43	36	CS25-110-7474
26.9	3/4	G3/4B	13.6	50	43	36	9	25.5	27.5	50.5	46	CS25-110-7575
33.7	1”	G1”B	14.1	50	51	41	9	30	21	51.5	50	CS25-110-7676

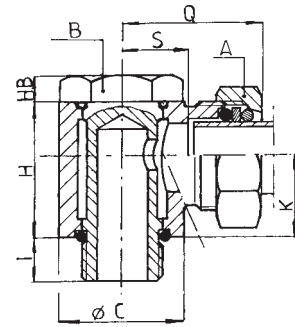

Yukarıda listelenen sipariş kodları standart bağlantı parçaları içindir. Diğer malzemeler, boyutlar ve ekipman istek üzerine gerçekleştirilebilir.  
The above listed order codes are for standard fittings. Other materials, sizes and equipment can be realised on request.

OR

CS25 Serisi / CS25 Series

Paralel Tek Banjo ISO / Parallel Single Banjo ISO

Tüp O.D mm	Tube O.D inch		I	C	H	B	HB	K	S	Q	A	Sipariş Kodu Order code Çelik Steel
6		M10X100	6.9	27.5	20.5	17	5	13	21	36.5	17	CS25-120-0610
8		M12X100	6.3	27.5	25.5	19	5	16	20	36.5	19	CS25-120-0812
10		M14X150	8.8	27.5	25.5	22	6	16	20	37	22	CS25-120-1014
12		M16X150	8.8	30	29.5	24	6	18	14.5	36	24	CS25-120-1216
14		M18X150	10.8	30	29.5	27	6	18	18	36	27	CS25-120-1418
16		M18X150	10.1	38	37	30	7	22	19	42	30	CS25-120-1620
18		M20X150	10.1	38	37	32	7	22	17.5	42	30	CS25-120-1822
20		M22X150	11.1	38	37	32	8	22	18.5	43	32	CS25-120-2024
22		M24X150	11.1	38	37	32	8	22	18	44	36	CS25-120-2224
25		M24X150	13.6	50	43	41	9	25.5	27.5	50.5	41	CS25-120-2530
28		M30X150	14.6	50	51	41	9	30	25	50.5	46	CS25-120-2833
30		M33X200	14.6	50	51	41	9	30	27	51.5	46	CS25-120-3033

10.2	1/8	M14X150	8.8	27.5	25.5	22	6	16	20	37	22	CS25-110-7114
13.5	1/4	M18X150	10.8	30	29.5	27	6	18	18	36	27	CS25-110-7218
17.2	3/8	M20X150	10.1	38	37	30	7	22	19	42	30	CS25-110-7320
21.3	1/2	M24X150	11.1	38	37	32	8	22	18	43	36	CS25-110-7424
26.9	3/4	M30X150	13.6	50	43	41	9	37.5	27.5	50.5	46	CS25-110-7530

Paralel Banjo Düşürücü BSPP / Parallel Banjo Reducer BSPP

6		G1/8B	5.9	17	20.5	17	5	12	7	28	17	CS02-330-0101
---	--	-------	-----	----	------	----	---	----	---	----	----	---------------

Paralel Banjo Düşürücü ISO / Parallel Banjo Reducer ISO

6		M10x100	5.9	17	20.5	17	5	12	7	28	17	CS02-260-0101
8		M12x100	6.3	17	25.5	19	5	16	8	29	19	CS02-200-0101

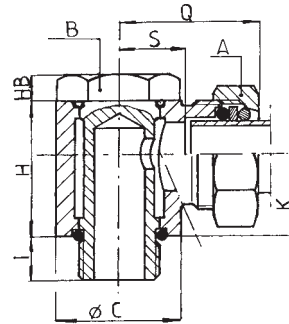

Yukarıda listelenen sipariş kodları standart bağlantı parçaları içindir. Diğer malzemeler, boyutlar ve ekipman istek üzerine gerçekleştirilebilir.

The above listed order codes are for standard fittings. Other materials, sizes and equipment can be realised on request.

PP

CS26 Serisi / CS26 Series

**Köprü Rakoru - ML 150 / Bridge Union - ML 150**

Tüp O.D	Tube O.D	A	C	MLE	Ağırlık (g)	Sipariş Kodu
mm	inch				Çelik Steel	Order code Çelik Steel
6		17	20	164	200	CS26-120-0615
8		19	20	164	230	CS26-120-0815
10		22	25	167	280	CS26-120-1015
12		24	25	168	360	CS26-120-1215
14		27	30	168	385	CS26-120-1415
15		27	30	167	380	CS26-120-1515
16		30	30	169	454	CS26-120-1615
18		30	30	169	486	CS26-120-1815
20		32	35	170	525	CS26-120-2015
22		36	35	173	635	CS26-120-2215
25		41	38	171	800	CS26-120-2515
28		46	40	172	978	CS26-120-2815
30		46	45	173	1100	CS26-120-3015
35		50	51	178	1153	CS26-120-3515
38		55	54	176	1202	CS26-120-3815
40		60	57	176	1400	CS26-120-4015
44.5		65	63.5	178	1900	CS26-120-4415

10.2	1/8	22	25	167	276	CS26-110-7115
13.5	1/4	27	30	168	400	CS26-110-7215
17.2	3/8	30	30	169	438	CS26-110-7315
21.3	1/2	36	35	170	590	CS26-110-7415
26.9	3/4	46	40	170	885	CS26-110-7515
33.7	1	50	51	173	1140	CS26-110-7615
42.4	1"1/4	65	60.3	176	1838	CS26-110-7715
48.3	1"1/2	70	70	176	1936	CS26-110-7815
60.3	2	85	82.5	180	3069	CS26-110-7915

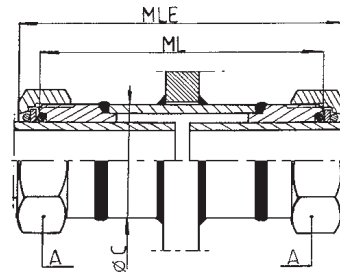

Yukarıda listelenen sipariş kodları standart bağlantı parçaları içindir. Diğer malzemeler, boyutlar ve ekipman istek üzerine gerçekleştirilebilir.  
The above listed order codes are for standard fittings. Other materials, sizes and equipment can be realised on request.

DPP

1/2 Köprü Rakoru - 1/2 Bridge Union

Tüp O.D Tube O.D		A	C	MLE 85	MLE 100	MLE 150	MLE 200	Sipariş Kodu Order code Çelik Steel
mm	inch			MLE	MLE	MLE	MLE	
6		17	20	92	107	157	207	CS27-120-0608
8		19	20	92	107	157	207	CS27-120-0808
10		22	25	94	109	159	209	CS27-120-1008
12		24	25	94	109	159	209	CS27-120-1208
14		27	30	94	109	159	209	CS27-120-1408
15		27	30	94	109	159	209	CS27-120-1508
16		30	30	95	110	160	210	CS27-120-1608
18		30	30	95	110	160	210	CS27-120-1808
20		32	35	95	110	160	210	CS27-120-2008
22		36	35	96	111	161	211	CS27-120-2208
25		41	38	95	110	160	210	CS27-120-2508
28		46	40	96	111	161	211	CS27-120-2808
30		46	45	96	111	161	211	CS27-120-3008
35		50	51	99	114	164	214	CS27-120-3508
38		55	54	97	112	162	212	CS27-120-3808
40		60	57	97	112	162	212	CS27-120-4008
44.5		65	63.5	99	114	164	214	CS27-120-4408

10.2	1/8	22	25	94	109	159	209	CS27-110-7108
13.5	1/4	27	30	94	109	159	209	CS27-110-7208
17.2	3/8	30	30	94.1	109	159	209	CS27-110-7308
21.3	1/2	36	35	95	110	160	210	CS27-110-7408
26.9	3/4	46	40	95	110	160	210	CS27-110-7508
33.7	1"	50	51	96	111	161	211	CS27-110-7608
42.4	1 1/4"	65	60.3	98	113	163	213	CS27-110-7708
48.3	1 1/2"	70	70	98	113	163	213	CS27-110-7808
60.3	2"	85	82.5	100	115	165	215	CS27-110-7908

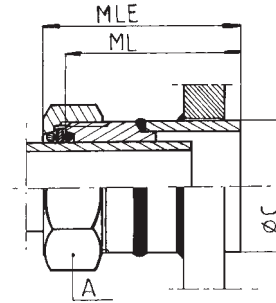

Yukarıda listelenen sipariş kodları standart bağlantı parçaları içindir. Diğer malzemeler, boyutlar ve ekipman istek üzerine gerçekleştirilebilir.  
The above listed order codes are for standard fittings. Other materials, sizes and equipment can be realised on request.



**OB**

CS28 Serisi / CS28 Series

**Kapak / Cap**

Tüp O.D Tube O.D		B	D	L	LB	Sipariş Kodu Order code
mm	inch					
6		12.6	6	3.5	1.5	CS28-009-06
8		14.6	8	3.5	1.5	CS28-009-08
10		16	10	3.5	1.5	CS28-009-10
12		18.9	12	4.5	1.5	CS28-009-12
14		20.9	14	4.5	1.5	CS28-009-14
15		21.9	15	4.5	1.5	CS28-009-15
16		22.9	16	5	2	CS28-009-16
18		24.8	18	5	2	CS28-009-18
20		26.8	20	5	2	CS28-009-20
22		30.8	22	6	2	CS28-009-22
25		33.8	25	6.5	2.5	CS28-009-25
28		35.7	28	6.5	2.5	CS28-009-28
30		39.7	30	6.5	2.5	CS28-009-30
35		43.7	35	6.5	2.5	CS28-009-35
38		46.7	38	6.5	2.5	CS28-009-38
40		49.7	40	7	3	CS28-009-40
44.5		57.6	44.5	9	3	CS28-009-44

10.2	1/8	16	10.2	3.5	1.5	CS28-009-71
13.5	1/4	20.9	13.5	4.5	1.5	CS28-009-72
17.2	3/8	23.9	17.2	5	2	CS28-009-73
21.3	1/2	29.8	21.3	6	2	CS28-009-74
26.9	3/4	35.8	26.9	6.5	2.5	CS28-009-75
33.7	1"	43.7	33.7	6.5	2.5	CS28-009-76
42.4	1 1/4	55.7	42.4	9	3	CS28-009-77
48.3	1 1/2	60.6	48.3	9	3	CS28-009-78
60.3	2"	73.6	60.3	9	3	CS28-009-79

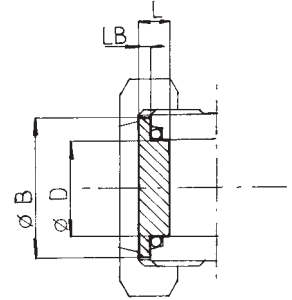

Yukarıda listelenen sipariş kodları standart bağlantı parçaları içindir. Diğer malzemeler, boyutlar ve ekipman istek üzerine gerçekleştirilebilir.  
The above listed order codes are for standard fittings. Other materials, sizes and equipment can be realised on request.

## EC-JT-RD

Somun / Nut		O-Ring / O-Ring			Pul / Washer					
Tüp O.D mm	Tube O.D inch	A	L	Ağırlık (g) Weight (g) Çelik Steel	Ø I.D.	Tore	N°	Ø O.D.	Ø I.D.(H12)	E
6		17	10.5	10	4.9	1.9	4	12.6	6.2	1.2
8		19	10.5	10	7.2	1.9	6	14.6	8.2	1.2
10		22	12	20	8.9	1.9	7	16	10.2	1.5
12		24	12	20	10.5	2.7	9	18.9	12.2	1.5
14		27	12	30	13.6	2.7	11	20.9	14.2	1.5
15		27	13	25	13.6	2.7	11	21.9	15.2	1.5
16		30	13.5	36	15.1	2.7	12	22.9	16.2	2
18		30	14.5	32	16.9	2.7	13	24.8	18.2	2
20		32	15	36	18.4	2.7	14	26.8	20.2	2
22		36	15.5	45	21.3	3.6	17	30.8	22.2	2
25		41	15	63	23	3.6	18	33.8	25.2	2.5
28		46	15	83	26.2	3.6	20	35.7	28.2	2.5
30		46	16	66	27.8	3.6	21	39.7	30.2	2.5
35		50	18	70	34.1	3.6	25	43.7	35.2	2.5
38		55	17	105	35.6	3.6	26	46.7	38.2	2.5
40		60	16	120	37.3	3.6	27	49.7	40.2	3
44.5		65	18.5	130	43.82	5.33	30	57.6	44.8	3

10.2	1/8	22	12	15	8.9	1.9	7	16	10.4	1.5
13.5	1/4	27	12	27	12.1	2.7	10	20.9	14	1.5
17.2	3/8	30	14	35	15.1	2.7	12	23.9	17.7	2
21.3	1/2	36	14.5	45	19.8	3.6	16	29.8	21.8	2
26.9	3/4	46	15	86	24.6	3.6	19	35.8	27.4	2.5
33.7	1"	50	16	72	32.5	3.6	24	43.7	34.2	2.5
42.4	1" 1/4	65	18	150	40.64	5.33	29	55.7	42.9	3
48.3	1" 1/2	70	18.5	176	46.99	5.33	31	60.6	48.8	3
60.3	2"	85	21	295	56.52	5.33	34	73.6	60.9	3

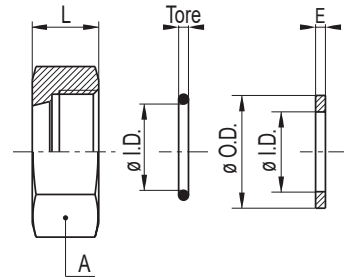

Yukarıda listelenen sipariş kodları standart bağlantı parçaları içindir. Diğer malzemeler, boyutlar ve ekipman istek üzerine gerçekleştirilebilir.

The above listed order codes are for standard fittings. Other materials, sizes and equipment can be realised on request.



**Merkez Ofis / Center Office**

100. Yıl Bulvarı Ostim Prestij İş Merkezi A/33-34  
Yenimahalle / 06374, Ankara TÜRKİYE

T: +90 312 911 73 02

**Almanya Fabrika / Germany Factory**

G595 Clariant, 65929 Frankfurt, Germany

**Çin Fabrika / China Factory**

86 Modaoqiao Rd, Yuyao, Ningbo, Zhejiang, China, 315400

E: [info@hydrointer.com](mailto:info@hydrointer.com)

© HydroInter